

Fitting for top-running wooden doors up to 100 kg (220 lbs.), with surface mounted running track. Optionally with soft and self closing mechanism. Wall or ceiling mounting.

Product highlights

- Flexibility** Ceiling mounting with customer-provided panelling or integrated clip-on panel in aluminium or wood
- Productivity** Retrofitting of all components through the provided assembly opening, prevents contamination during construction work
- Aesthetics** Also available in black as a "Black Edition" design option for a particularly attractive appearance

Technical specifications

- Max. 100 kg (220 lbs.)
- Max. 2700 mm (8'10 5/16")
- Max. 1600 mm (5'3")
- 30–80 mm (1 3/16" to 3 5/32")

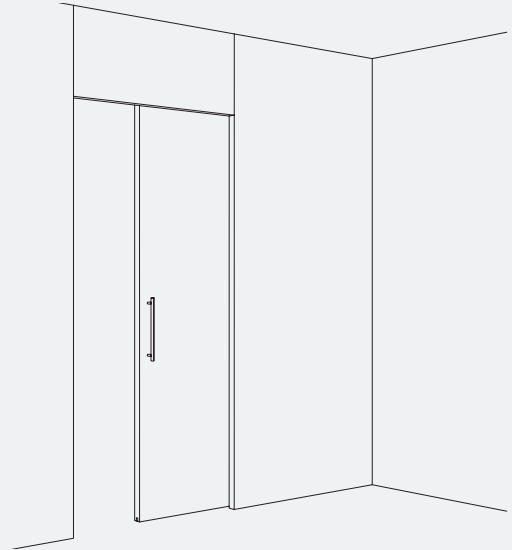

Installation examples

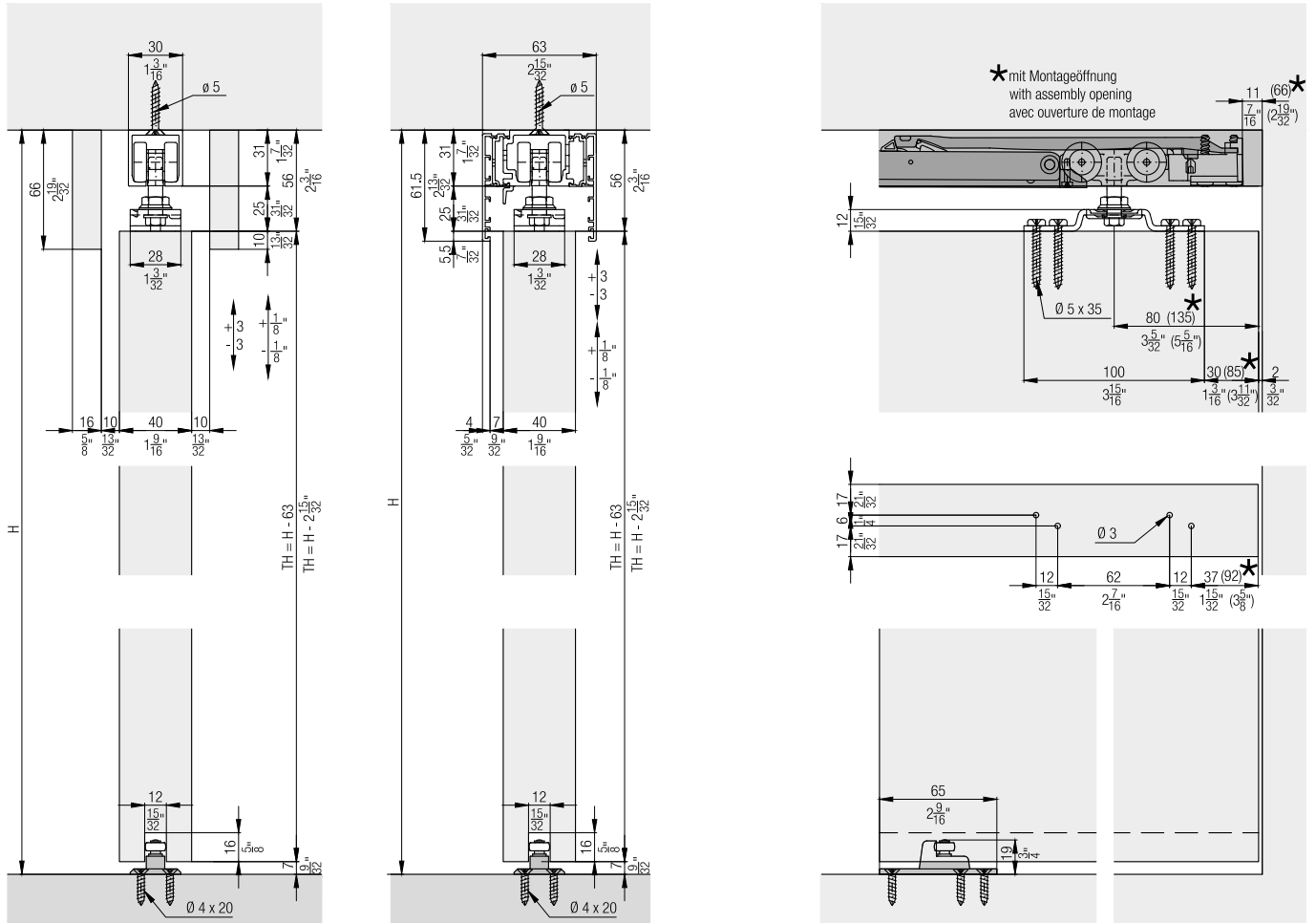

**Set for ceiling or wall mounting,  
for 1 wooden door up to 100 kg (220 lbs.)**

	No.
Hawa Porta/Divido 100 H/HC, for 1 door	057.3139.071
Hawa Porta 100 H/HC, black, for 1 door	057.3139.075

**Set consisting of:**

		057.3139.071	057.3139.075	No.
	Running gear, ball bearing, rollers plastic white	2	2	057.3114.071
	Stopper, with retention spring, plastic, gray	2		057.3073.072
	Suspension bolt, M8x32 mm (5/16"x1 1/4"), steel, zinc-plated	2	2	057.0123.104
	Hexagon locking nut, M8, steel, zinc-plated	2	2	768.9005.101
	Support bracket, height and lateral adjustable, steel, zinc-plated	2	2	057.3129.101
	Pan head screw, 5x35 mm (3/16"x1 3/8"), steel, zinc-plated	8	8	766.6051.135
	Bottom guide, with roller, adjustable, plastic, anthracite	1	1	057.3120.071
	Countersunk head screw, 4x20 mm (5/32"x25/32"), steel, zinc-plated	4		766.5042.120
	Stopper, with retention spring, plastic, black		2	057.3073.076
	Countersunk head screw, 4x20 mm, steel, zinc-plated		4	600.0000.817



**Set for ceiling or wall mounting,  
for 1 wooden door up to 100 kg (220 lbs.)**

	No.
Hawa Porta 100 H, with running track, 2000 mm (6' 6 3/4"), aluminum, anodized, for 1 door	057.3141.071

**Set consisting of:**

		mm (inch)	057.3141.071	No.
	Running gear, ball bearing, rollers plastic white		2	057.3114.071
	Stopper, with retention spring, plastic, gray		2	057.3073.072
	Suspension bolt, M8x32 mm (5/16"x1 1/4"), steel, zinc-plated		2	057.0123.104
	Hexagon locking nut, M8, steel, zinc-plated		2	768.9005.101
	Support bracket, height and lateral adjustable, steel, zinc-plated		2	057.3129.101
	Pan head screw, 5x35 mm (3/16"x1 3/8"), steel, zinc-plated		8	766.6051.135
	Bottom guide, with roller, adjustable, plastic, anthracite		1	057.3120.071
	Countersunk head screw, 4x20 mm (5/32"x25/32"), steel, zinc-plated		4	766.5042.120
	Track cleaner, plastic, blue		1	057.3099.071
	Running track, aluminum, anodized, pre-drilled	2,000 (6' 6 3/4 ")	1	057.3016.201

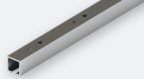
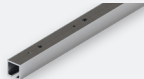
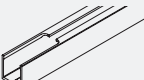
**Running tracks**

		mm (inch)	No.
	Running track, aluminum, pre-drilled	1,700 (5' 6 15/16")	057.3016.170
		2,000 (6' 6 3/4 ")	057.3016.200
		2,500 (8' 2 7/16")	057.3016.250
		6,000 (19' 8 7/32")	057.3016.600
		cut to size	057.3016.990
	Running track, aluminum, anodized, pre-drilled	2,000 (6' 6 3/4 ")	057.3016.201
		2,500 (8' 2 7/16")	057.3016.251
		6,000 (19' 8 7/32")	057.3016.601
		cut to size	057.3016.991
	Running track, with assembly opening, aluminum, anodized, pre-drilled	2,500 (8' 2 7/16")	057.3016.256
		cut to size	057.3016.998
	Combi running track, aluminum, pre-drilled	1,700 (5' 6 15/16")	057.3048.170
		2,000 (6' 6 3/4 ")	057.3048.200
		2,500 (8' 2 7/16")	057.3048.250
		3,500 (11' 5 25/32")	057.3048.350
		6,000 (19' 8 7/32")	057.3048.600
		cut to size	057.3048.990
	Combi running track, aluminum, black anodized, pre-drilled	2,500 (8' 2 7/16")	057.3048.255
3,500 (11' 5 25/32")		057.3048.355	
	Disposable cover to running track Hawa Porta 45/60/100, plastic, black	2,000 (6' 6 3/4 ")	057.3098.001
		cut to size	057.3098.990

**Assembly set**

	No.	
	Assembly set Hawa Porta 60/100, 2000 mm (6' 6 3/4")	057.3179.200
	Assembly set Hawa Porta 60/100, 2500 mm (8' 2 7/16")	057.3179.250
	Assembly set Hawa Porta 60/100, 3000 mm (9' 10 1/8")	057.3179.300

Set consisting of:	mm (inch)				No.
		057.3179.200	057.3179.250	057.3179.300	
 Running track, aluminum, anodized, pre-drilled	2,000 (6' 6 3/4 ")	1			057.3174.200
 Assembly pin, plastic, gray		9	11	13	057.0201.001
 Countersunk head screw, 5x40 mm (3/16"x1 9/16"), steel, zinc-plated		10	12	14	766.3054.140
 Running track, aluminum, anodized, pre-drilled	2,500 (8' 2 7/16")		1		057.3174.250
 Running track, aluminum, anodized, pre-drilled	3,000 (9' 10 1/8 ")			1	057.3174.300

**Panels**

	mm (inch)	No.
	2,500 (8' 2 7/16")	042.3004.250
	3,500 (11' 5 25/32")	042.3004.350
	6,000 (19' 8 7/32")	042.3004.600
	cut to size	042.3004.990
	Clip-on panel, aluminum, black anodized	2,500 (8' 2 7/16")
3,500 (11' 5 25/32")		042.3004.355





**Clip-on components**

		No.
	Clip component for wooden and aluminum panel, every 500 mm (1'7 11/16"), aluminium, pre-drilled	057.3117.001
	Clip component for wooden and aluminum panel, every 500 mm (1'7 11/16"), aluminium, black anodized, pre-drilled	057.3117.005



**Soft close**

**Sets for single- or both-sided steaming**

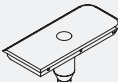

	No.
Set of 2 soft close, Hawa Porta 100, Divido 100, 61–100 kg (133–220 lbs.)	52425
Set of 2 soft close, Hawa Porta 60/100, Divido 100, 10–60 kg (22–132 lbs.)	52426
Soft close Hawa Porta 100, Divido 100, 61–100 kg (133–220 lbs.), 1 piece	042.3102.071
Soft close Hawa Porta 60/100, Divido 100, 10–60 kg (22–132 lbs.), 1 piece	042.3102.072

Set consisting of:	52425	52426	042.3102.071	042.3102.072	No.
		2		1	
	2	2	1	1	042.3105.001
	2	2	1	1	600.0000.566
		2		1	042.3106.072

**Cover for assembly opening**

		No.
Cover cap to assembly opening, 1-piece set		042.3114.071
		No.
	Cover cap assembly opening, plastic, gray	1 042.0172.001
	Screw set soft close	1 600.0000.566



**Bracket set for wall mounting**

		No.
Angle bracket for wall mounting, steel, zinc-plated, 10-piece set		057.3005.172
		No.
Set consisting of:		057.3005.172
	Wall mounting angle bracket, steel, zinc-plated	10 057.0169.101
	Countersunk head screw, M5x12 mm (3/16"x15/32"), steel, zinc-plated	10 762.5008.100
	Hexagon nut, M5, steel, zinc-plated	10 768.9025.100

**Bottom guide set for wall mounting**

		No.
	Set bottom guide for wall mounting, with roller	057.3128.171

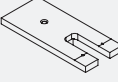
**Accessories**

		No.
	Routing jig for assembly opening	042.3118.071
	Groove cutter to routing jig, Ø= 10 mm (13/32"), hard metal	600.0000.309
	Track cleaner, plastic, blue	057.3099.071

**Assembly set/Wooden panel**

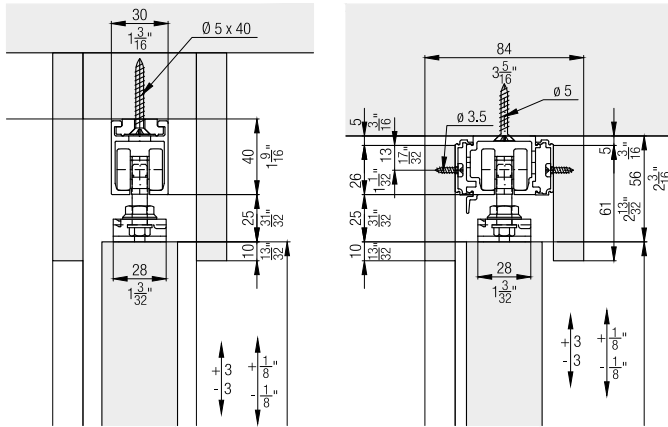

**Optional: Wall mounting**

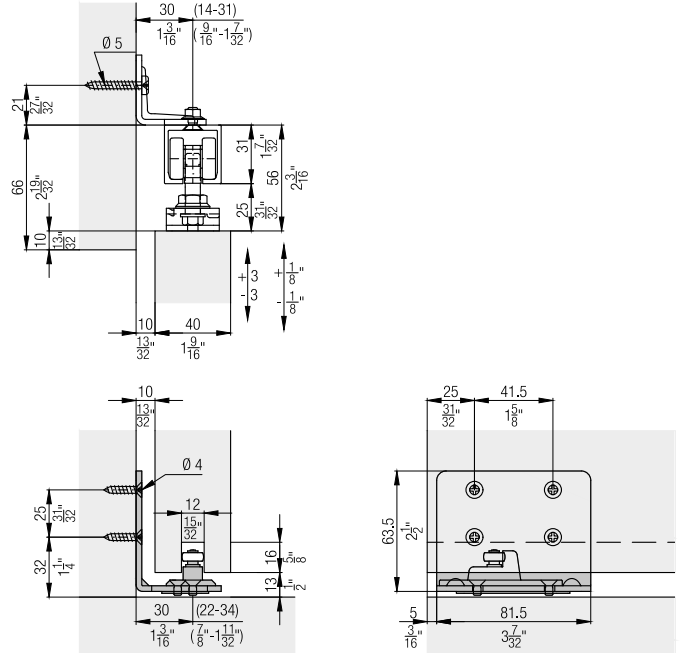

**Soft close**

Technical drawings and tables for soft close mechanism. The top drawing shows a side view of the door assembly with dimensions:  $\geq 320$  ( $\geq 1' 19/32"$ ),  $Z \geq 535$ ,  $Z \geq 1' 9 1/16"$ . The bottom drawing shows a side view of the door assembly with dimensions:  $\geq 570$  ( $\geq 1' 10 7/16"$ ),  $Z \geq 840$ ,  $Z \geq 2' 9 1/16"$ .

	Z =					
	1			2		
	0	1	2	0	1	2
Hawa Porta 60/100 H/HC	1' 6 29/32"	1' 9 1/16"	1' 11 1/4"	2' 4 3/4"	2' 6 29/32"	2' 9 3/32"
Hawa Porta 60/100 HM/HMD/HMT	1' 6 29/32"	1' 9 1/16"	1' 11 1/4"	2' 4 3/4"	2' 6 29/32"	2' 9 3/32"
Hawa Porta 100 G/GU/GM/GMT	1' 6 29/32"	1' 9 1/16"	1' 11 1/4"	2' 4 3/4"	2' 6 29/32"	2' 9 3/32"
Hawa Porta 100 GF	1' 6 29/32"	X	X	2' 4 3/4"	X	X
Hawa Porta 100 GW/GWF	1' 8 5/32"	1' 9 11/32"	1' 11 1/4"	2' 6"	2' 6 29/32"	2' 7 3/16"
Hawa Porta 100 GMD	1' 7 7/32"	1' 9 7/32"	1' 11 1/4"	2' 5 1/16"	2' 7 1/16"	2' 7 3/16"
Hawa Divido 100 H/HM/GR	1' 6 29/32"	1' 9 1/16"	1' 11 1/4"	2' 4 3/4"	2' 6 29/32"	2' 9 3/32"
Hawa Divido 100 GRM	1' 8 5/32"	1' 10 11/32"	1' 0 1/2"	2' 6"	2' 8 5/32"	2' 10 11/32"

	Z =					
	1			2		
	0	1	2	0	1	2
Hawa Porta 60/100 H/HC	480	535	590	730	785	840
Hawa Porta 60/100 HM/HMD/HMT	480	535	590	730	785	840
Hawa Porta 100 G/GU/GM/GMT	480	535	590	730	785	840
Hawa Porta 100 GF	480	X	X	730	X	X
Hawa Porta 100 GW/GWF	512	542	590	762	792	840
Hawa Porta 100 GMD	488	539	590	738	789	840
Hawa Divido 100 H/HM/GR	480	535	590	730	785	840
Hawa Divido 100 GRM	512	567	622	762	817	872

**\* Montageöffnung assembly opening ouverture de montage**

Diagram of the assembly opening with dimensions: 62 (2 7/16"), 32 (1 1/4"), 32 (1 1/4"), 32 (1 1/4").

**Bidseitig gedämpfte Ausführungen ohne stinseitigen Zugang erfordern zwei Montageöffnungen.**  
**Versions with soft closing mechanism at both sides without access from the leading edge require two assembly openings.**  
**Les versions avec amortissement bilatéral sans accès frontal exigent deux ouvertures de montage.**

**Accessories**

- Lock solutions from page 511
- General accessories from page 518

**Planning/execution**

Further information about the product can be found on [www.hawa.com](http://www.hawa.com).