

Fitting for top-running wooden doors up to 60 kg (132 lbs.), with surface mounted running track. Optionally with soft and self closing mechanism. Wall or ceiling mounting.

Product highlights

- Flexibility** Ceiling mounting with customer-provided panelling or integrated clip-on panel in aluminium or wood
- Productivity** Retrofitting of all components through the provided assembly opening, prevents contamination during construction work
- Aesthetics** Also available in black as a "Black Edition" design option for a particularly attractive appearance

Technical specifications

- Max. 60 kg (132 lbs.)
- Max. 2700 mm (8'10 5/16")
- Max. 1600 mm (5'3")
- 30–80 mm (1 3/16" to 3 5/32")



Installation examples

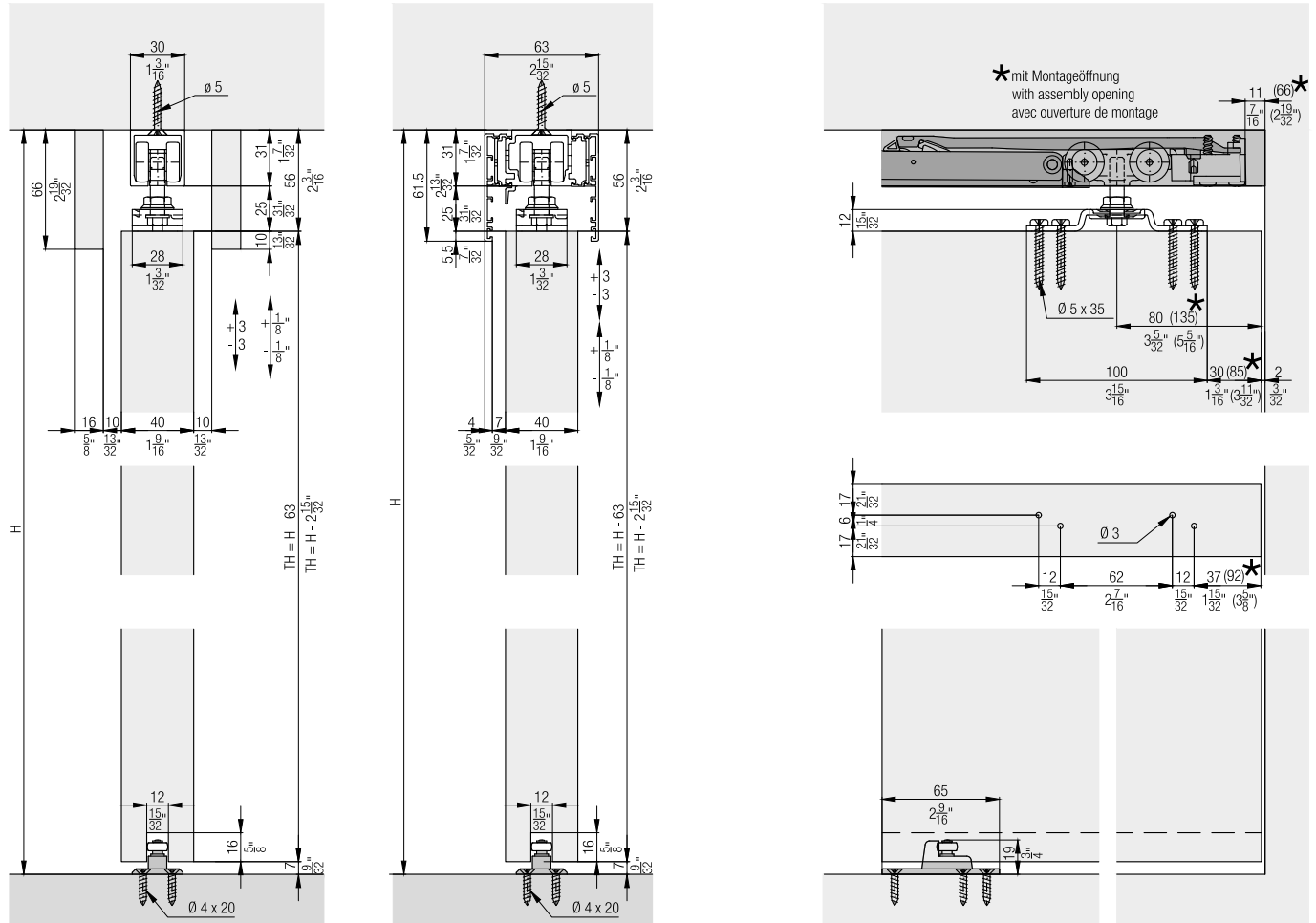

**Set for ceiling or wall mounting,
for 1 wooden door up to 60 kg (132 lbs.)**

	No.
Hawa Porta 60 H/HC, for 1 door	057.3138.071
Hawa Porta 60 H/HC, black, for 1 door	057.3138.075

Set consisting of:

		057.3138.071	057.3138.075	No.
	Running gear, plain bearings, rollers plastic blue	2	2	057.3115.071
	Stopper, with retention spring, plastic, gray	2		057.3073.072
	Suspension bolt, M8x32 mm (5/16"x1 1/4"), steel, zinc-plated	2	2	057.0123.104
	Hexagon locking nut, M8, steel, zinc-plated	2	2	768.9005.101
	Support bracket, height and lateral adjustable, steel, zinc-plated	2	2	057.3129.101
	Pan head screw, 5x35 mm (3/16"x1 3/8"), steel, zinc-plated	8	8	766.6051.135
	Bottom guide, with roller, adjustable, plastic, anthracite	1	1	057.3120.071
	Countersunk head screw, 4x20 mm (5/32"x25/32"), steel, zinc-plated	4		766.5042.120
	Stopper, with retention spring, plastic, black		2	057.3073.076
	Countersunk head screw, 4x20 mm, steel, zinc-plated		4	600.0000.817



**Set for ceiling or wall mounting,
for 1 wooden door up to 60 kg (132 lbs.)**

	No.
Hawa Porta 60 H, with running track, 2000 mm (6' 6 3/4"), aluminum, for 1 door	057.3140.071

Set consisting of:

		mm (inch)	057.3140.071	No.
	Running gear, plain bearings, rollers plastic blue		2	057.3115.071
	Stopper, with retention spring, plastic, gray		2	057.3073.072
	Suspension bolt, M8x32 mm (5/16"x1 1/4"), steel, zinc-plated		2	057.0123.104
	Hexagon locking nut, M8, steel, zinc-plated		2	768.9005.101
	Support bracket, height and lateral adjustable, steel, zinc-plated		2	057.3129.101
	Pan head screw, 5x35 mm (3/16"x1 3/8"), steel, zinc-plated		8	766.6051.135
	Bottom guide, with roller, adjustable, plastic, anthracite		1	057.3120.071
	Countersunk head screw, 4x20 mm (5/32"x25/32"), steel, zinc-plated		4	766.5042.120
	Running track, aluminum, pre-drilled	2,000 (6' 6 3/4")	1	057.3016.200

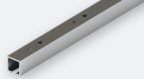
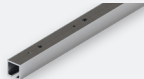
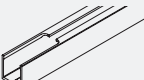
Running tracks

		mm (inch)	No.
	Running track, aluminum, pre-drilled	1,700 (5' 6 15/16")	057.3016.170
		2,000 (6' 6 3/4 ")	057.3016.200
		2,500 (8' 2 7/16")	057.3016.250
		6,000 (19' 8 7/32")	057.3016.600
		cut to size	057.3016.990
	Running track, aluminum, anodized, pre-drilled	2,000 (6' 6 3/4 ")	057.3016.201
		2,500 (8' 2 7/16")	057.3016.251
		6,000 (19' 8 7/32")	057.3016.601
		cut to size	057.3016.991
	Running track, with assembly opening, aluminum, anodized, pre-drilled	2,500 (8' 2 7/16")	057.3016.256
		cut to size	057.3016.998
	Combi running track, aluminum, pre-drilled	2,000 (6' 6 3/4 ")	057.3048.200
		2,500 (8' 2 7/16")	057.3048.250
		3,500 (11' 5 25/32")	057.3048.350
		6,000 (19' 8 7/32")	057.3048.600
		cut to size	057.3048.990
	Combi running track, aluminum, black anodized, pre-drilled	2,500 (8' 2 7/16")	057.3048.255
3,500 (11' 5 25/32")		057.3048.355	
	Disposable cover to running track Hawa Porta 45/60/100, plastic, black	2,000 (6' 6 3/4 ")	057.3098.001
		cut to size	057.3098.990

Assembly set

		No.
	Assembly set Hawa Porta 60/100, 2000 mm (6' 6 3/4")	057.3179.200
	Assembly set Hawa Porta 60/100, 2500 mm (8' 2 7/16")	057.3179.250
	Assembly set Hawa Porta 60/100, 3000 mm (9' 10 1/8")	057.3179.300

		mm (inch)	057.3179.200	057.3179.250	057.3179.300	No.
Set consisting of:						
	Running track, aluminum, anodized, pre-drilled	2,000 (6' 6 3/4 ")	1			057.3174.200
	Assembly pin, plastic, gray		9	11	13	057.0201.001
	Countersunk head screw, 5x40 mm (3/16"x1 9/16"), steel, zinc-plated		10	12	14	766.3054.140
	Running track, aluminum, anodized, pre-drilled	2,500 (8' 2 7/16")		1		057.3174.250
	Running track, aluminum, anodized, pre-drilled	3,000 (9' 10 1/8 ")			1	057.3174.300

Panels

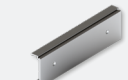
		mm (inch)	No.
	Clip-on panel, aluminum, anodized	2,500 (8' 2 7/16")	042.3004.250
		3,500 (11' 5 25/32")	042.3004.350
		6,000 (19' 8 7/32")	042.3004.600
		cut to size	042.3004.990
	Clip-on panel, aluminum, black anodized	2,500 (8' 2 7/16")	042.3004.255
		3,500 (11' 5 25/32")	042.3004.355



Clip-on components

		No.
	Clip component for wooden and aluminum panel, every 500 mm (1'7 11/16"), aluminium, pre-drilled	057.3117.001
	Clip component for wooden and aluminum panel, every 500 mm (1'7 11/16"), aluminum, black anodized, pre-drilled	057.3117.005

Soft close



Sets for single- or both-sided steaming

		No.
Set of 2 soft close, Hawa Porta 60/100, Divido 100, 10–60 kg (22–132 lbs.)		52426
Soft close Hawa Porta 60/100, Divido 100, 10–60 kg (22–132 lbs.), 1 piece		042.3102.072

		52426	042.3102.072	No.
Set consisting of:				
	Soft close, top running, 10–60 kg (22 to 132 lbs.), plastic	2	1	042.3106.072
	Trigger for soft close in buildings, zinc die casting	2	1	042.3105.001
	Screw set soft close	2	1	600.0000.566

Cover for assembly opening

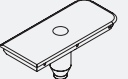

		No.
Cover cap to assembly opening, 1-piece set		042.3114.071

		042.3114.071	No.
Set consisting of:			
	Cover cap assembly opening, plastic, gray	1	042.0172.001
	Screw set soft close	1	600.0000.566

Bracket set for wall mounting

		No.
Angle bracket for wall mounting, steel, zinc-plated, 10-piece set		057.3005.172

		057.3005.172	No.
Set consisting of:			

	Wall mounting angle bracket, steel, zinc-plated	10	057.0169.101
	Countersunk head screw, M5x12 mm (3/16"x15/32"), steel, zinc-plated	10	762.5008.100
	Hexagon nut, M5, steel, zinc-plated	10	768.9025.100

Bottom guide set for wall mounting

		No.
	Set bottom guide for wall mounting, with roller	057.3128.171

Accessories

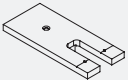
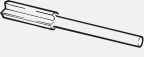
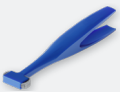
		No.
	Routing jig for assembly opening	042.3118.071
	Groove cutter to routing jig, Ø= 10 mm (13/32"), hard metal	600.0000.309
	Track cleaner, plastic, blue	057.3099.071

Assembly set/Wooden panel

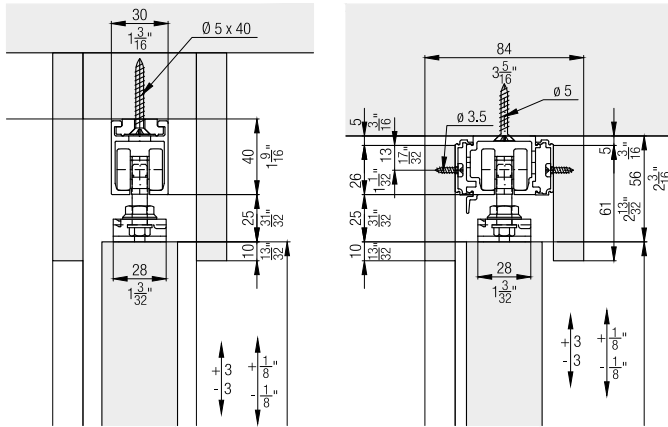

Optional: Wall mounting

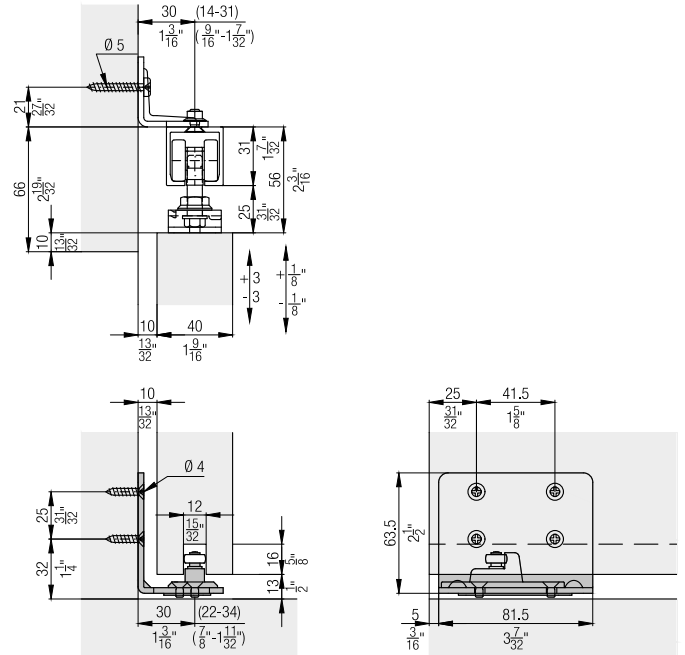

Soft close

*	Z =					
	1			2		
	0	1	2	0	1	2
Hawa Porta 60/100 H/HC	1' 6 29/32"	1' 9 1/16"	1' 11 1/4"	2' 4 3/4"	2' 6 29/32"	2' 9 3/32"
Hawa Porta 60/100 HM/HMD/HMT	1' 6 29/32"	1' 9 1/16"	1' 11 1/4"	2' 4 3/4"	2' 6 29/32"	2' 9 3/32"
Hawa Porta 100 G/GU/GM/GMT	1' 6 29/32"	1' 9 1/16"	1' 11 1/4"	2' 4 3/4"	2' 6 29/32"	2' 9 3/32"
Hawa Porta 100 GF	1' 6 29/32"	X	X	2' 4 3/4"	X	X
Hawa Porta 100 GW/GWF	1' 8 5/32"	1' 9 11/32"	1' 11 1/4"	2' 6"	2' 6 29/32"	2' 7 3/16"
Hawa Porta 100 GMD	1' 7 7/32"	1' 9 7/32"	1' 11 1/4"	2' 5 1/16"	2' 7 1/16"	2' 7 3/16"
Hawa Divido 100 H/HM/GR	1' 6 29/32"	1' 9 1/16"	1' 11 1/4"	2' 4 3/4"	2' 6 29/32"	2' 9 3/32"
Hawa Divido 100 GRM	1' 8 5/32"	1' 10 11/32"	1' 0 1/2"	2' 6"	2' 8 5/32"	2' 10 11/32"

*	Z =					
	1			2		
	0	1	2	0	1	2
Hawa Porta 60/100 H/HC	480	535	590	730	785	840
Hawa Porta 60/100 HM/HMD/HMT	480	535	590	730	785	840
Hawa Porta 100 G/GU/GM/GMT	480	535	590	730	785	840
Hawa Porta 100 GF	480	X	X	730	X	X
Hawa Porta 100 GW/GWF	512	542	590	762	792	840
Hawa Porta 100 GMD	488	539	590	738	789	840
Hawa Divido 100 H/HM/GR	480	535	590	730	785	840
Hawa Divido 100 GRM	512	567	622	762	817	872

$Z \geq 320$
 $\geq 1' 19 1/32"$
 $Z \geq 535$
 $Z \geq 1' 9 1/16"$

$Z \geq 570$
 $\geq 1' 10 7/16"$
 $Z \geq 840$
 $Z \geq 2' 9 1/16"$

* Montageöffnung
 assembly opening
 ouverture de montage

Beidseitig gedämpfte Ausführungen ohne stinseitigen Zugang erfordern zwei Montageöffnungen.
 Versions with soft closing mechanism at both sides without access from the leading edge require two assembly openings.
 Les versions avec amortissement bilatéral sans accès frontal exigent deux ouvertures de montage.

Accessories

- Lock solutions from page 511
- General accessories from page 518

Planning/execution

Further information about the product can be found on www.hawa.com.