

Fitting for bottom-running wooden doors up to 80 kg (176 lbs.), with surface or recess mounted running track. With soft and self closing mechanism.

Product highlights

- Flexibility** One, two or three track system for doors or room dividers
- Productivity** Multi-track guide and running tracks reduce installation cost

Technical specifications

- Max. 80 kg (176 lbs.)
- Max. 2400 mm (7' 10 7/16")
- Max. 2000 mm (6' 6 3/4")
- 28–30 mm (1 3/32" to 1 3/16")

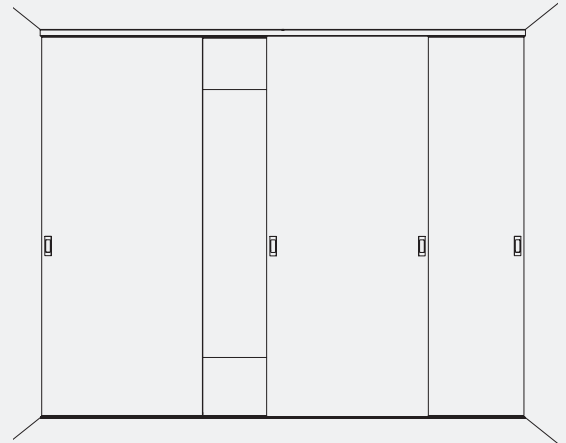

Installation examples

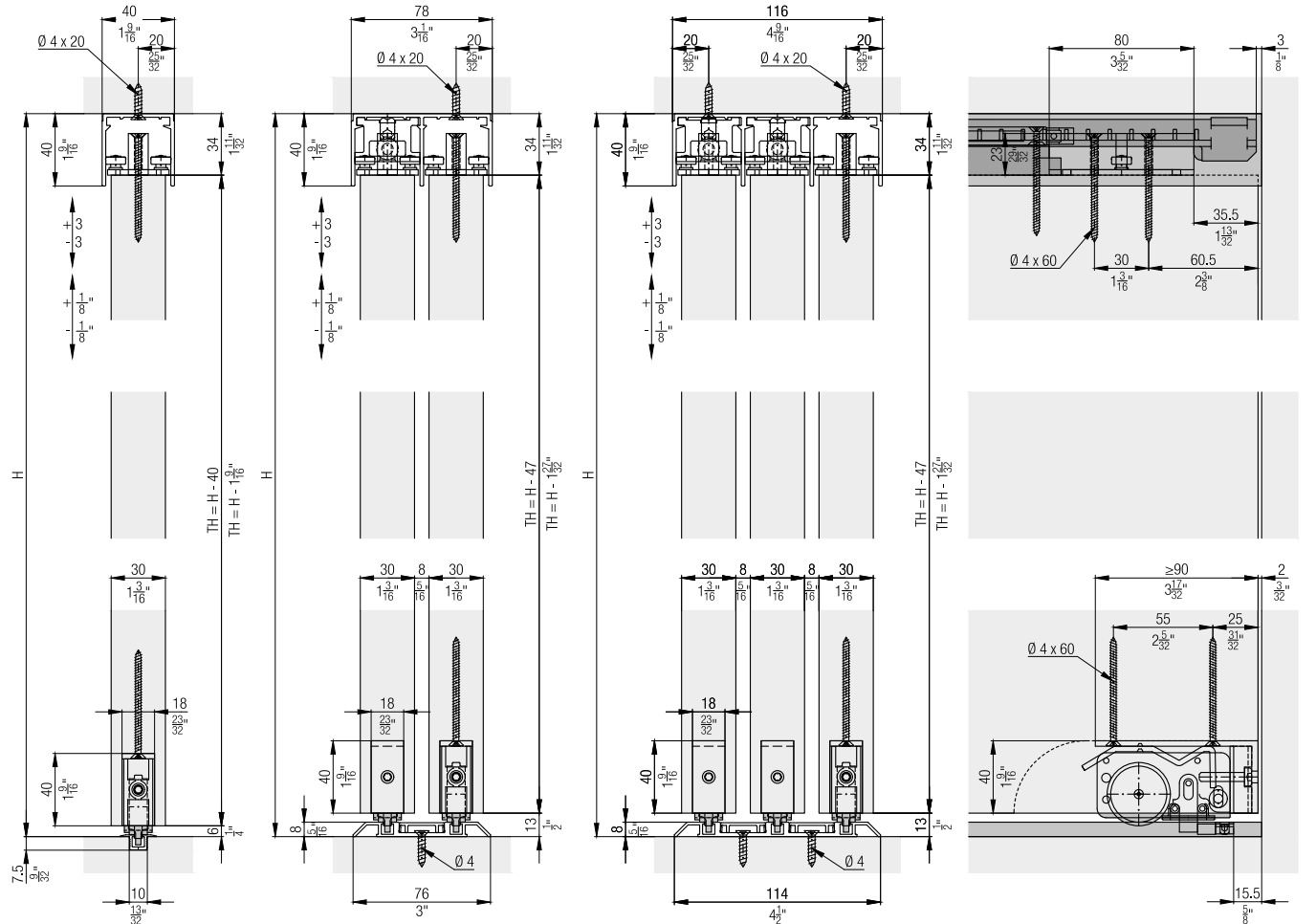





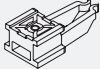

**Set for 1 wooden door up to 80 kg (176 lbs.)**

	No.
Hawa Divido 80 H, for 1 door	042.3026.075

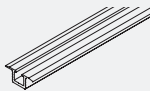
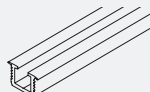
		042.3026.075	No.
<b>Set consisting of:</b>			

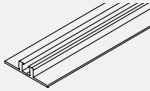
	Running gear, bottom running, steel	2	042.3018.071
	Adapter for wooden door, plastic, anthracite	2	042.3036.001
	Flat countersunk head chipboard screw, 4x60 mm (5/32"x2 3/8"), steel, zinc-plated	4	600.0000.139
	Stopper to running track Hawa Divido 80, plastic, grey	2	042.3008.071
	Soft closing gum, plastic, grey	2	042.0126.001
	Track end piece, plastic, grey	1	042.3046.001
	Set top guide	1	042.3032.172
	Stopper to guide track, plastic, grey	2	042.3012.071

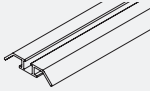

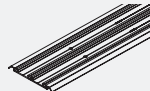
**Running tracks (overview on page 503)**

		mm (inch)	No.
	Running track, aluminum, anodized, flush mounted	6,000 (19' 8 7/32")	042.3089.600
		cut to size	042.3089.990
	Single running track for 042.3039., aluminum, anodized	2,500 (8' 2 7/16")	042.3037.250
		3,500 (11' 5 25/32")	042.3037.350
		6,000 (19' 8 7/32")	042.3037.600
		cut to size	042.3037.990
	Mounting track for 042.3037., aluminum, anodized	6,000 (19' 8 7/32")	042.3039.600
		cut to size	042.3039.990
	Single running track, aluminum, anodized, surface mounted	6,000 (19' 8 7/32")	042.3040.600
		cut to size	042.3040.990
	Double running track, aluminum, anodized, pre-drilled, surface mounted	6,000 (19' 8 7/32")	042.3041.600
		cut to size	042.3041.990
	Single running track, for glue fixing, aluminum, anodized, surface mounted	6,000 (19' 8 7/32")	042.3080.600
		cut to size	042.3080.990
	Double running track, aluminum, anodized, pre-drilled, surface mounted	6,000 (19' 8 7/32")	042.3081.600
		cut to size	042.3081.990
	Triple running track, aluminum, anodized, pre-drilled, surface mounted	6,000 (19' 8 7/32")	042.3082.600
		cut to size	042.3082.990
	Clip cover for 042.3039./042.3041./042.3081./042.3082., aluminum, anodized	6,000 (19' 8 7/32")	042.3038.600
		cut to size	042.3038.990

**Track end piece set for single running tracks**

		No.
	Track-end piece to 042.3089., plastic, gray, 2-piece set	042.3090.081
	Track-end piece to 042.3080., plastic, gray, 2-piece set	042.3087.081



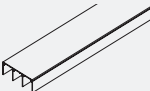



**Guide tracks**

		mm (inch)	No.
	Single guide track, aluminum, anodized	2,500 (8' 2 7/16")	042.3049.250
		3,500 (11' 5 25/32")	042.3049.350
		6,000 (19' 8 7/32")	042.3049.600
		cut to size	042.3049.990
	Double guide track, aluminum, anodized, flush mounting	2,500 (8' 2 7/16")	042.3011.250
		3,500 (11' 5 25/32")	042.3011.350
		6,000 (19' 8 7/32")	042.3011.600
		cut to size	042.3011.990
	Triple guide track, aluminum, anodized	6,000 (19' 8 7/32")	042.3085.600
		cut to size	042.3085.990

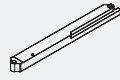
**Soft close**

**For soft closing in opening and closing direction  
order 2 sets.**

	No.
Soft close Hawa Divido 80, 61–80 kg (133 to 176 lbs.), 1 piece	042.3103.071
Soft close Hawa Divido 80, 10–60 kg (22 to 132 lbs.), 1 piece	042.3103.072

		042.3103.071	042.3103.072	No.
<b>Set consisting of:</b>				
	Soft close, bottom running, 61–80 kg (134 to 176 lbs.), plastic	1		042.3107.071
	Damper support, bottom running, plastic	1	1	042.3108.001
	Support bracket, bottom running, steel, zinc-plated	1	1	042.3110.101
	Stopper with trigger, plastic	1	1	042.3109.071
	Flat countersunk head chipboard screw, 4x60 mm (5/32"x2 3/8"), steel, zinc-plated	2	2	600.0000.139
	Cross recessed flat countersunk head screw, M4x50 mm (5/32"x1 31/32"), steel, zinc-plated	2	2	600.0000.492
	Soft close, bottom running, 10–60 kg (22 to 132 lbs.), plastic		1	042.3107.072

**Wall compensation profiles**

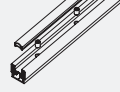
		mm (inch)	No.
	Wall compensation profile, with sealing profile gray, aluminum, anodized	2,500 (8' 2 7/16")	042.3064.071
		3,000 (9' 10 1/8")	042.3064.072

**Intermediate stop**

**(cannot be used in conjunction with  
soft closing mechanism)**

		No.
	Intermediate stop, plastic, gray	042.3031.071

Further installation examples

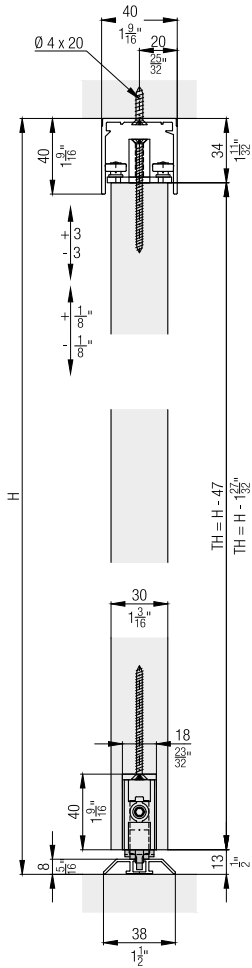

Calculations

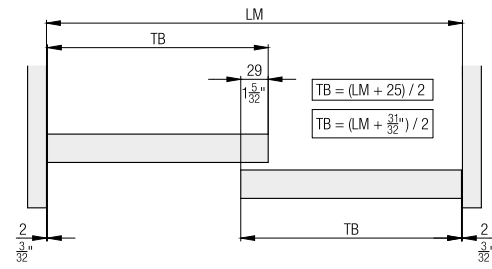

Wall compensation profile

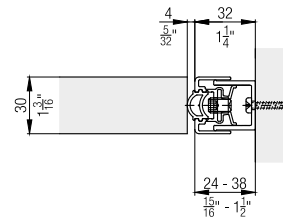

Installation examples running tracks

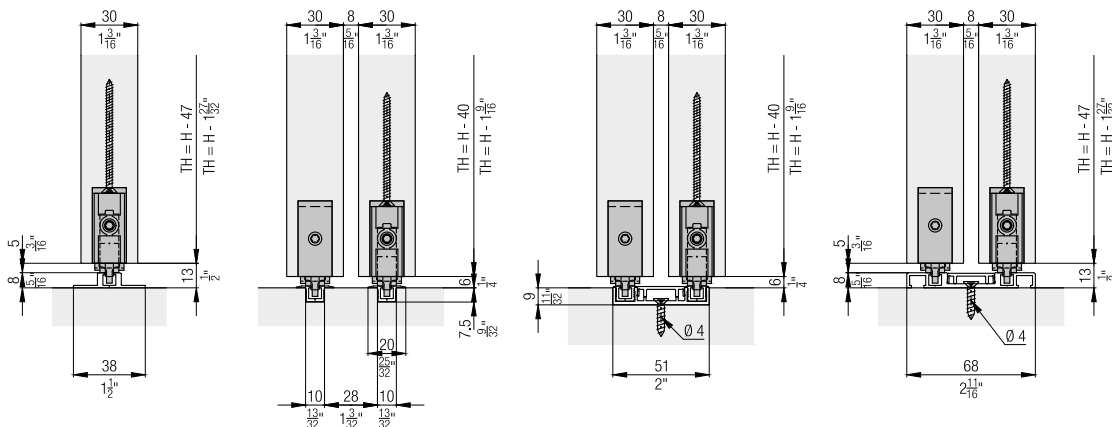

Overview running tracks

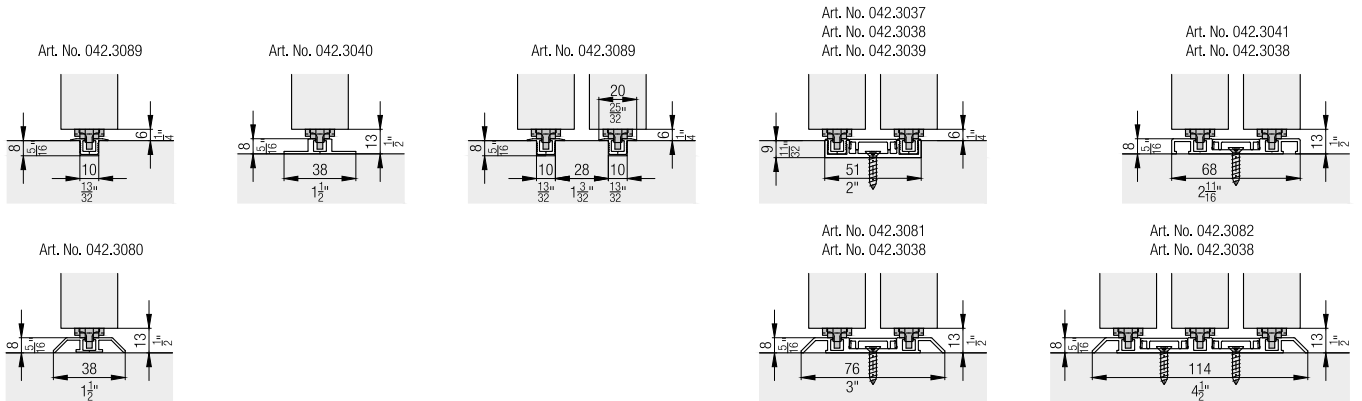

Soft close

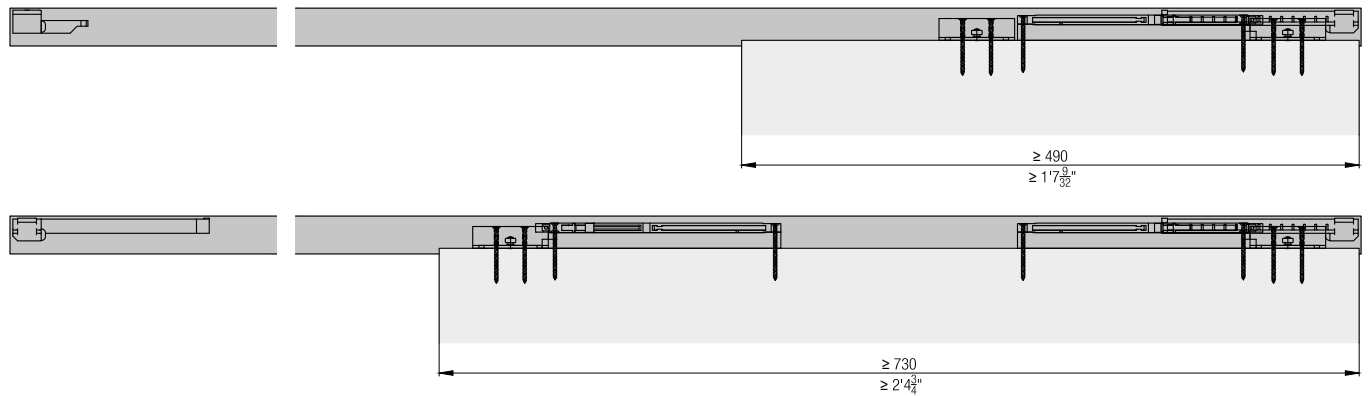

Accessories

– Hawa Divido overview from page 503

Planning/execution

Further information about the product can be found on [www.hawa.com](http://www.hawa.com).