







Fitting for 2–3 bottom-running wooden doors up to 35 kg (77 lbs.) with screwed on running track. Soft close optional. Design Forslide.

Product highlights

-  **Comfort** High operating convenience thanks to proven running system and optional soft closing technology
-  **Productivity** No cabinet processing, high degree of pre-assembly and access from the front for easy, quick installation

Technical specifications

-  Max. 35 kg (77 lbs.)
-  Max. 2200 mm (7'2 5/8")
-  Max. 1200 mm (3'11 1/4")
-  19 mm (3/4")

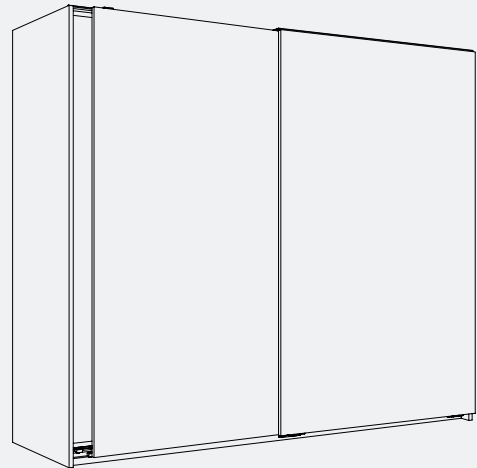

Installation examples

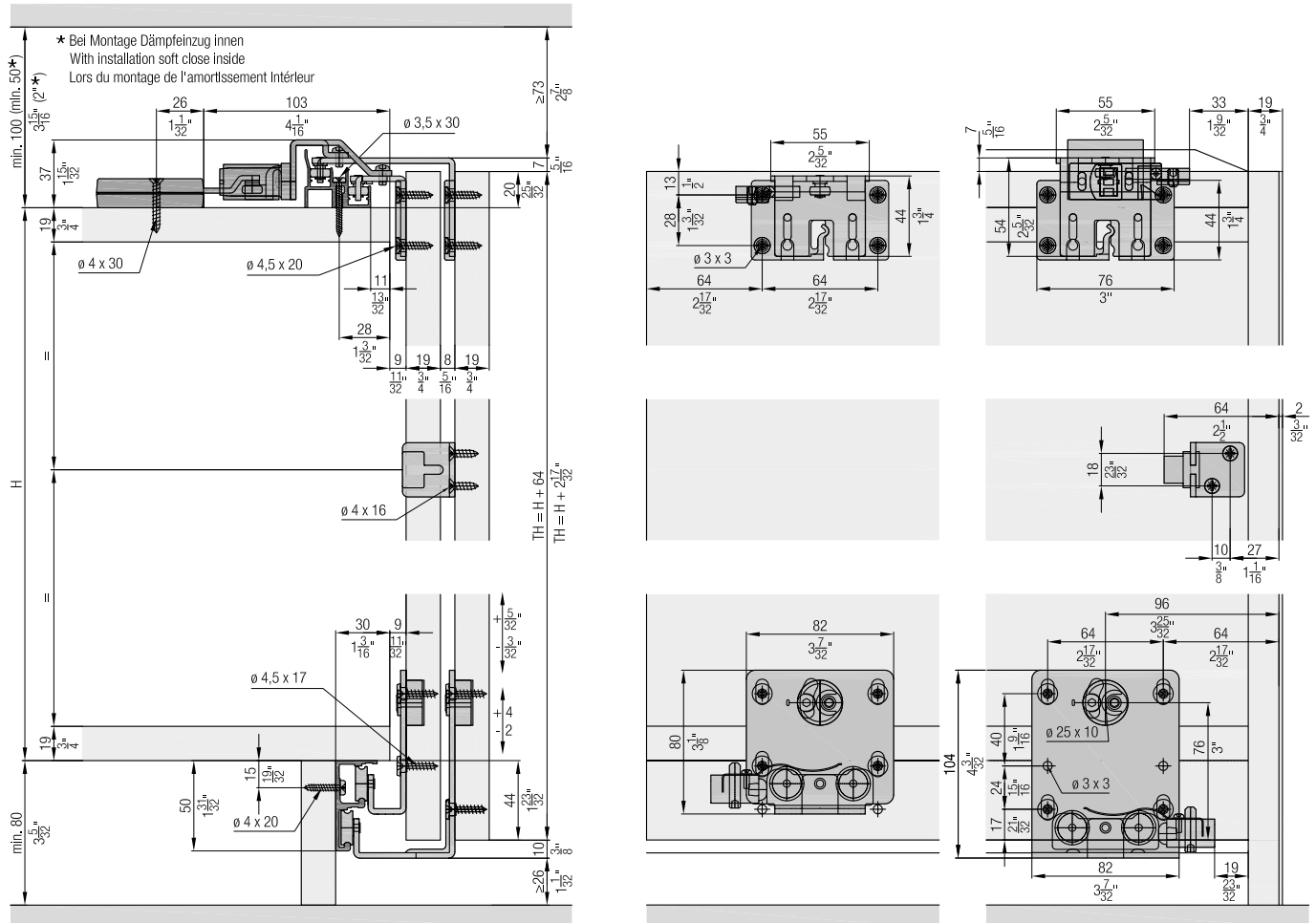

Set for 2 wooden doors

	Nr.
Hawa Combino 35 H FS, for 2 doors	056.3182.073
Hawa Combino 35 H FS, for 3 doors	056.3182.074

Set consisting of:

		056.3182.073	056.3182.074	Nr.
	Running gear, interior door, steel, zinc-plated	2	4	056.3187.171
	Running gear, exterior door, steel, zinc-plated	2	2	056.3188.171
	Guide bracket, interior door, steel, zinc-plated	2	4	055.3107.171
	Guide bracket, exterior door, steel, zinc-plated	2	2	055.3108.171
	Guide bracket housing, plastic, anthracite	4	6	053.3064.001
	Stopper, plastic, gray	2	1	056.3189.071
	Stopper, with retention spring, plastic, gray	2	3	056.3189.072
	Stopper guide, plastic, gray	4	4	040.3079.074
	Door follower, with 2 doors, steel, zinc-plated	1		055.3124.071
	Washer and screw assembly, 4.5x17 mm, steel, zinc-plated	16	24	055.0100.101
	Countersunk head screw, 4.5x20 mm, steel, zinc-plated	16	24	600.0000.167
	Buffer, with adhesive, 3-piece set		1	061.3083.050
	Door follower, with 3 doors, steel, zinc-plated		2	055.3126.171
	Thread-cutting rounded head screw, M4x8 mm, steel, zinc-plated		2	600.0000.328

Running tracks

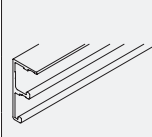
		mm (inch)	Nr.
	Double running track, aluminum, anodized, pre-drilled	2500 (8'2 7/16")	056.3184.250
		3500 (11'5 25/32")	056.3184.350
		6000 (19'8 7/32")	056.3184.600

Guide tracks

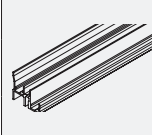

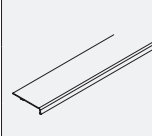

		mm (inch)	Nr.
	Double guide track, aluminum, anodized, pre-drilled	2500 (8'2 7/16")	056.3072.250
		3500 (11'5 25/32")	056.3072.350
		6000 (19'8 7/32")	056.3072.600

Panels

		mm (inch)	Nr.
	Cover panel, aluminum, anodized	2500 (8'2 7/16")	055.3130.250
		3500 (11'5 25/32")	055.3130.350
		6000 (19'8 7/32")	055.3130.600

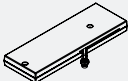



**Soft close (installation outside)
(only for system with 2 doors)
Adapter soft close (installation outside)
must be ordered separately**

	Nr.
Soft close, 18–40 kg (40–88 lbs.), with narrow follower, 2 pieces	055.3091.074

		055.3091.074	Nr.
Set consisting of:			
	Soft close, left, 18–40 kg (40–88 lbs.)	1	055.3090.073
	Soft close, right, 18–40 kg (40–88 lbs.)	1	055.3090.074
	Follower, for soft close, right, plastic, gray	1	055.3041.071
	Follower, for soft close, left, plastic, gray	1	055.3041.072
	Fillister head screw, 4x16 mm, steel, zinc-plated	4	600.0000.166
	Countersunk head screw, 4x30 mm, steel, zinc-plated	4	600.0000.439





**Adapter soft close (installation outside)
for No. 055.3091.074**

	Nr.
Adapter set, for soft close	055.3129.071

		055.3129.071	Nr.
Set consisting of:			
	Adapter, for soft close, interior door, top, steel, zinc-plated	1	055.0211.101
	Adapter, for soft close, exterior door, top, steel, zinc-plated	1	055.0212.101
	Rounded head screw, M4x8 mm, steel, zinc-plated	4	759.0408.108
	Thread-cutting rounded head screw, M4x8 mm, steel, zinc-plated	4	600.0000.328

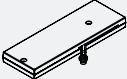
**Soft close (installation inside)
(only for system with 2 doors)**

	Nr.
Soft close, 18–40 kg (40–88 lbs.), with wide follower, 2 pieces	055.3091.073

		055.3091.073	Nr.
Set consisting of:			
	Soft close, left, 18–40 kg (40–88 lbs.)	1	055.3090.073
	Soft close, right, 18–40 kg (40–88 lbs.)	1	055.3090.074
	Follower, for soft close, right, plastic, gray	1	055.3040.071
	Follower, for soft close, left, plastic, gray	1	055.3040.072
	Fillister head screw, 4x16 mm, steel, zinc-plated	6	600.0000.166
	Countersunk head screw, 4x30 mm, steel, zinc-plated	4	600.0000.439

Accessories

	Nr.	
	Intermediate stop set, for 3 doors	055.3128.071

Soft close installation inside (only for system with 2 doors)

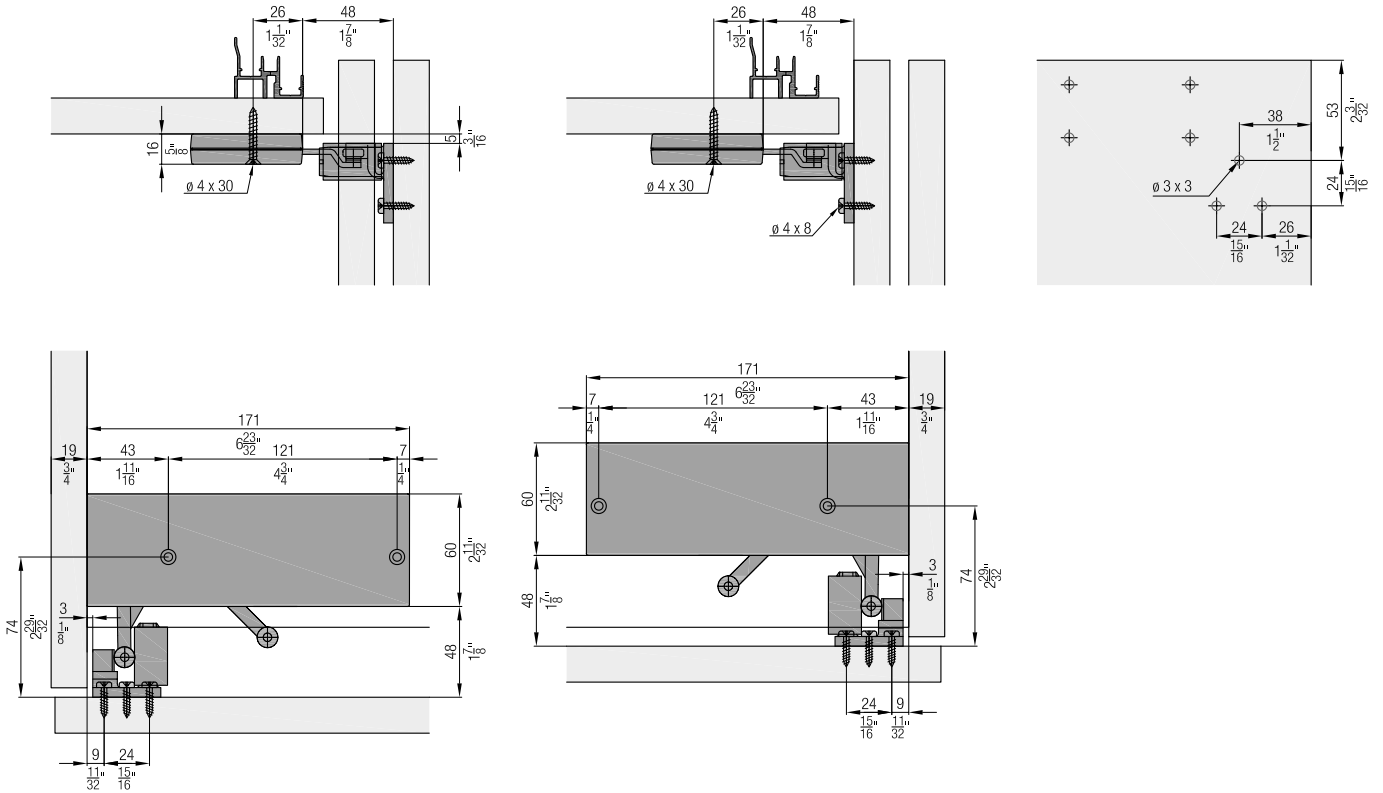

Soft close installation outside (only for system with 2 doors)

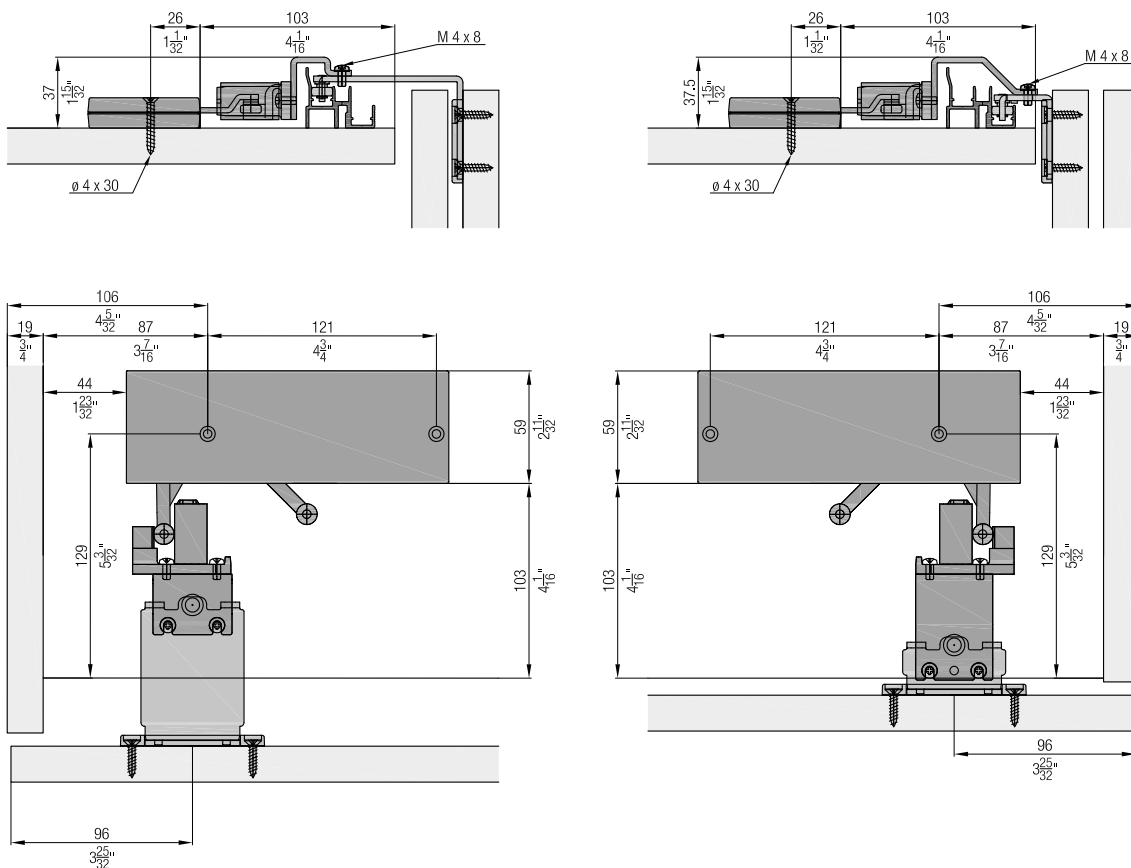

Calculations

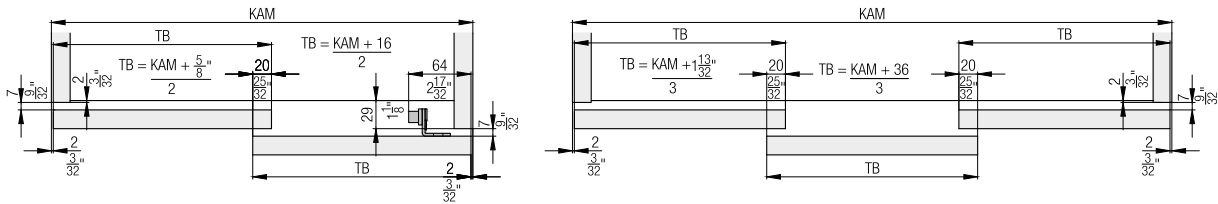

Optional: Guide track installation from below

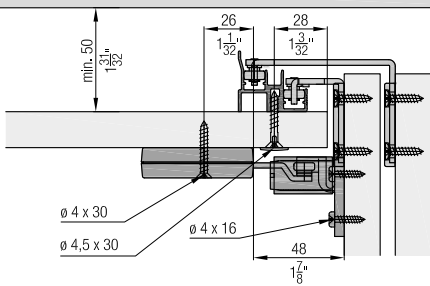

Intermediate stop with 3 doors

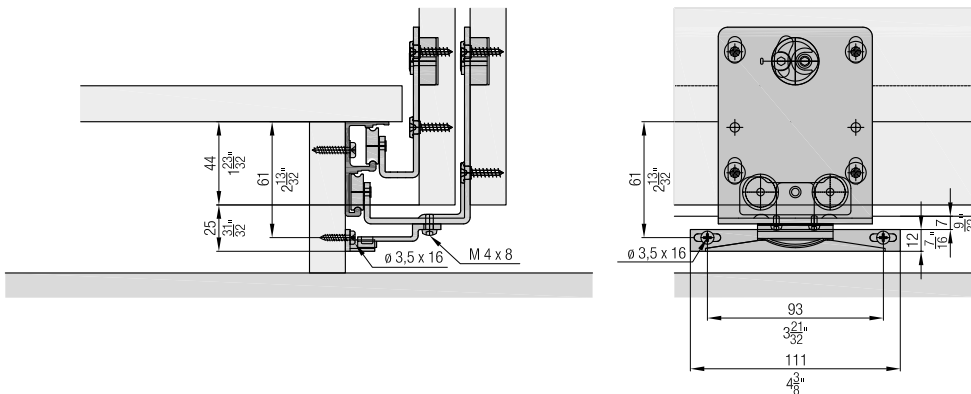

Handle profile

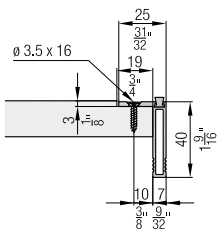

Accessories

- Straightening fitting from page 236
- Handle profiles from page 238
- Order overview soft close from page 240

Planning/execution

Further information about the product can be found on www.hawa.com.