

Furniture hardware system for sliding folding cabinet/wardrobe doors which can be freely moved to and fro. Panel weight up to 30 kg (66 lbs).

Description

With the Hawa Multifold 30, two cabinet/wardrobe doors can be folded as panel pairs and moved to and fro. The number of panel pairs is not limited. Several pairs of panels can be joined using an adapter. Cabinet designs can incorporate inlaying, semi-overlaying and overlaying cabinet doors. The side panels, top, bottom and shelves are all the same width. The cupboard interior space is not restricted by any protruding hardware elements. A horizontal brush seal in the top track and bottom guide channel protects against dust and deadens impact noise. For the centre groove a rubber seal can be used which protects the cupboard interior and hinges against dust. The panel pairs can be locked with a furniture bar bolt lock. The hardware system is also suitable for fixing the panels on the side.

Applications

This hardware system is suitable for use in interior design and furniture manufacturing wherever quality and simple operation with extremely smooth and stable running is required, e.g. interiors, hotels, etc.

Features of the Hawa Multifold 30

- Maximum panel weight 30 kg (66 lbs.), panel pair 60 kg (132 lbs.)
- Maximum panel heights 2600 mm (8'6 3/8")
- Panel widths – free slideable, 200–500 mm (7 7/8"–1'7 11/16")
- Panel widths – side hinged, 200–650 mm (7 7/8"–2'1 19/32")
- Panel thicknesses 19–25 mm (3/4"–63/64")
- Vertical groove width 3–5 mm (1/8"–13/64")
- Vertical adjustment ± 2 mm (3/32")

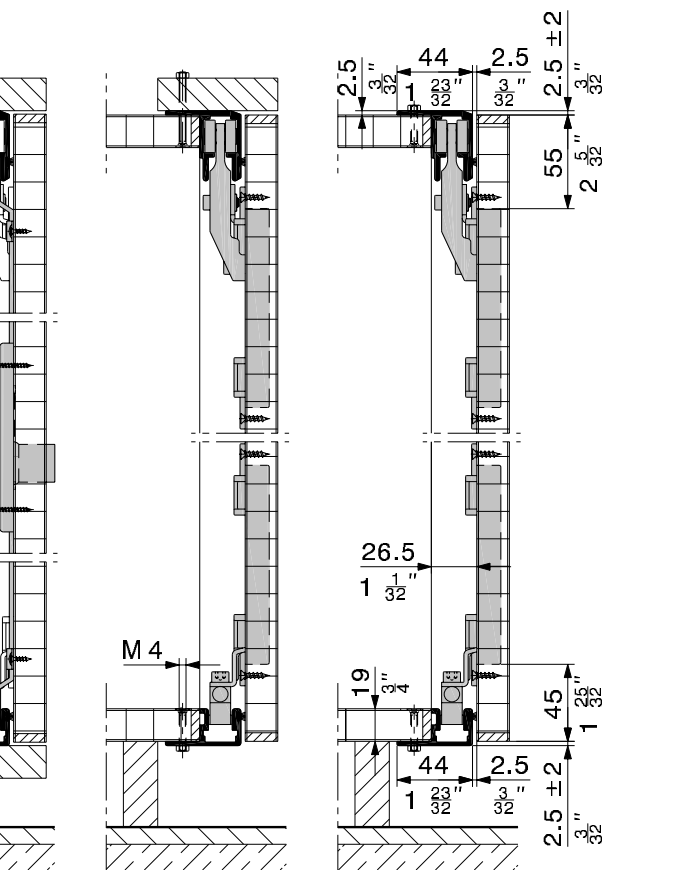
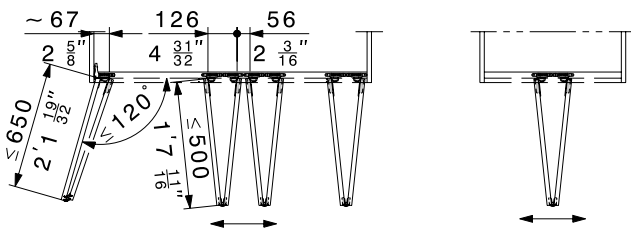

Inlaying doors Semi-overlaying doors Overlaying doors

Walk-in cabinet

A walk-in cabinet version is also possible. Please see also Hawa Multifold 30 W.

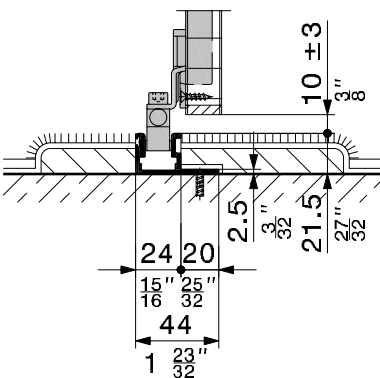

Subject to modification. Metric specifications are exact. Inches are approximate.

Cabinet design versions

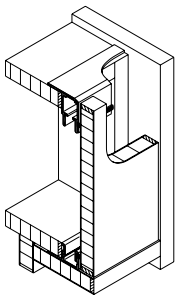

Semi-overlaying with visible face

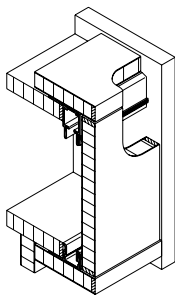

Inlaying

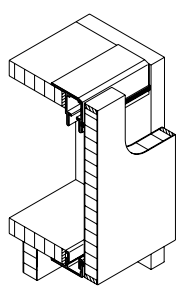

Overlaying

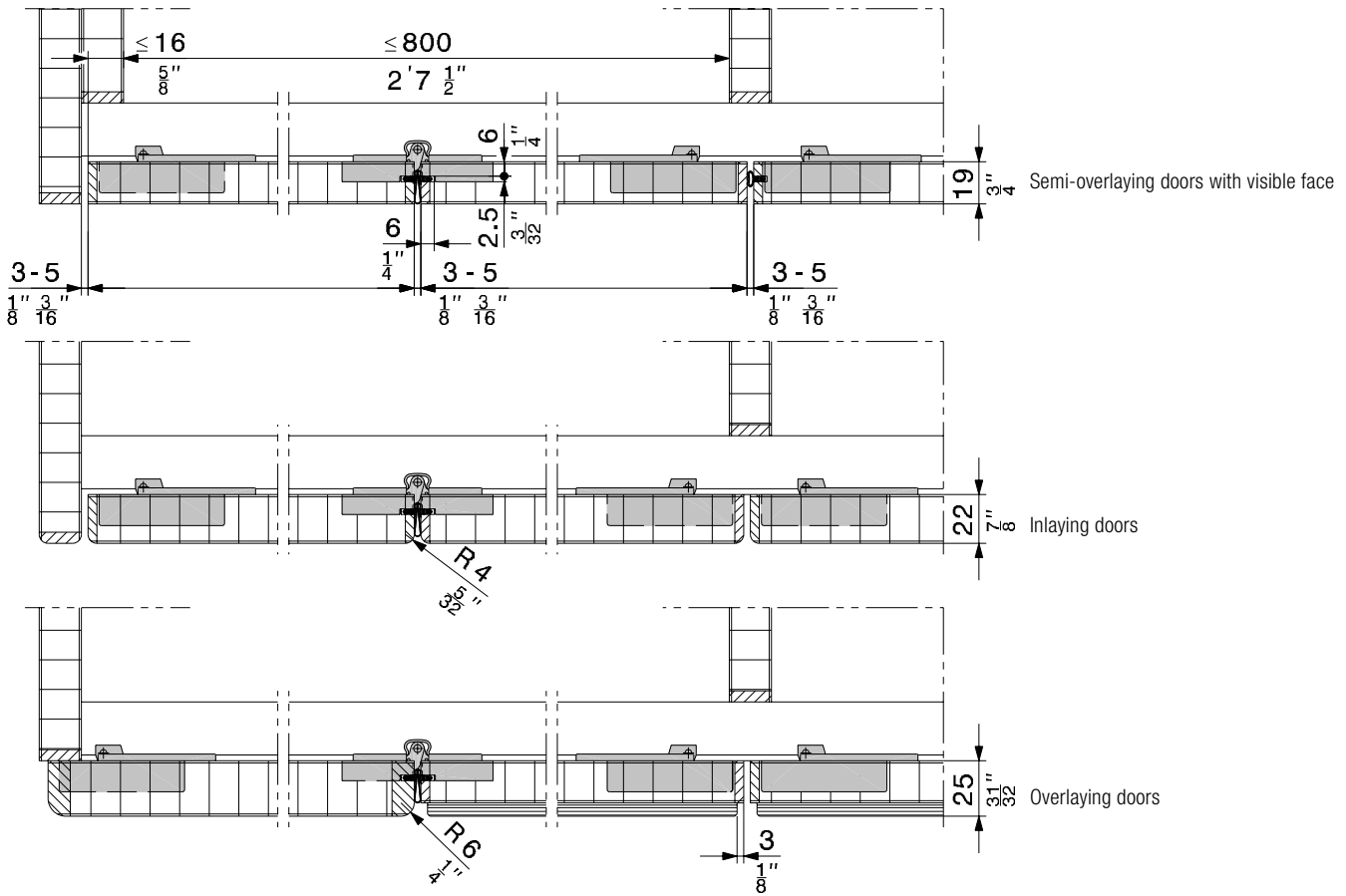



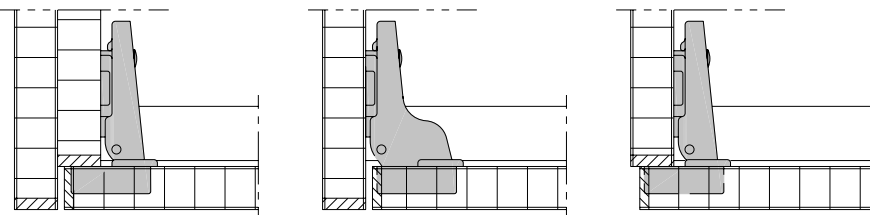

Side attachment

For side attachment, standard 110° concealed hinges with springs can be used.



Subject to modification. Metric specifications are exact. Inches are approximate.

Sets without profile set

		maximum panel widths	panels	code
	«Two-panel cabinet/wardrobe» set	500 mm (1'7 ¹¹ / ₁₆ "	2	15037
	«Exterior type» set (for left and right-hand use)	500 mm (1'7 ¹¹ / ₁₆ "	2	15276
	«Central type» set	500 mm (1'7 ¹¹ / ₁₆ "	2	15039
	«Sidefit type» set, without concealed hinges (for left and right-hand use)	650 mm (2'1 ¹³ / ₃₂ "	2	15040

Profile sets

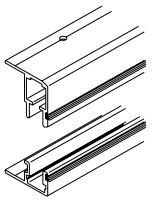
Caution: Hole positions vary		mm/inch	code
	Top track and bottom guide channel, alu plain anodized, with brush seal	1100 (3'7 ⁵ / ₈ "	15024
		1800 (5'10 ⁷ / ₈ "	15025
		2500 (8'2 ⁷ / ₁₆ "	15026
		3500 (11'5 ¹³ / ₁₆ "	15027
		6000 (19'8 ⁷ / ₃₂ "	15290



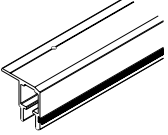
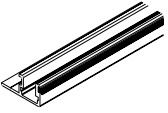



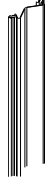





Profile set comprising

Caution: Hole positions vary		mm/inch	15024	15025	15026	15027	15290	code
	Top track, alu plain anodized, predrilled, with brush seal	1100 (3'7 ⁵ / ₈ "	1	-	-	-	-	15014
		1800 (5'10 ⁷ / ₈ "	-	1	-	-	-	15015
		2500 (8'2 ⁷ / ₁₆ "	-	-	1	-	-	15016
		3500 (11'5 ¹³ / ₁₆ "	-	-	-	1	-	15017
		6000 (19'8 ⁷ / ₃₂ "	-	-	-	-	1	15288
	Bottom guide channel, alu plain anodized, predrilled, with brush seal	1100 (3'7 ⁵ / ₈ "	1	-	-	-	-	15019
		1800 (5'10 ⁷ / ₈ "	-	1	-	-	-	15020
		2500 (8'2 ⁷ / ₁₆ "	-	-	1	-	-	15021
		3500 (11'5 ¹³ / ₁₆ "	-	-	-	1	-	15022
		6000 (19'8 ⁷ / ₃₂ "	-	-	-	-	1	15289

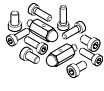
Vertical seal profiles, styrene-butadiene rubber (SBR)

			code
	Seal profile, white, similar RAL 9010	5-m roll (16'4 ²⁷ / ₃₂ "	15227
	Seal profile, black, similar RAL 9011	5-m roll (16'4 ²⁷ / ₃₂ "	15224

Set comprising

			15037	15276	15039	15040	code
	Trolley with 2 plastic tyred wheels and 2 guide rollers		2	2	2	1	15032
	Suspension unit		2	2	2	1	15029
	Floor guide unit, short		2	1	-	1	15030
	Floor guide unit, long		-	1	2	-	15034
	Roller-guide set, 2 overlaying doors		-	-	-	1	18570
	Set of countersunk head press. screws, 4 x 16 mm (⁵ / ₁₆ " x ⁵ / ₈ "	12 pieces	-	-	-	1	15035
		24 pieces	1	1	1	-	14908
	Set of fixing screws	to 15037	1	-	-	-	15031
		to 15276	-	1	-	-	15277
		to 15039	-	-	1	-	15110
		to 15040	-	-	-	1	15036
	Spring-concealed centre hinge, with fixing screws		3	3	3	-	14904
	Centre hinge, with fixing screws		-	-	-	3	15041
	Door catch, plastic black, with fixing screws		1	1	1	1	15033
	Retaining bumper on top		2	1	-	1	14960
	Stop bumper, at the bottom		2	1	-	1	14957

Arrangement and number of hinges

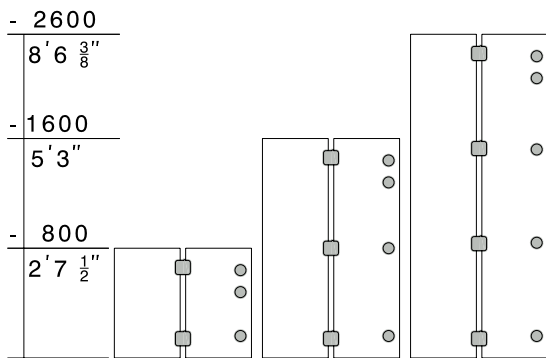

On the outer side commercially available concealed spring-loaded hinges for inset doors, $\geq 110^\circ$, may be used

Grooves for vertical sealing profile

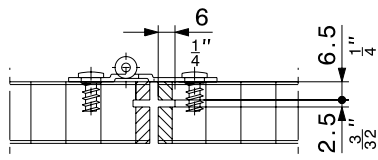

Hinged to side version

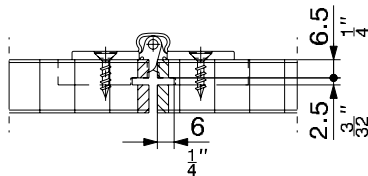

Not hinged to side version

Accessories

		code
	Folding panel connecting elements for two pairs of folding sliding doors (2-piece set)	14933
	Panel surface equalizer, plastic black (2-piece set)	14906
	Furniture bar bolt lock, 27/110/8 mm ($1\frac{1}{16}''/4\frac{21}{32}''/5/16''$), nickel finish, with 1 EURO key, 2 half-round rods, 1500 mm ($4'11\frac{1}{16}''$) strike plates (simultaneous locking)	left 20875
		right 20876
	Furniture bar bolt lock, 27/110/8 mm ($1\frac{1}{16}''/4\frac{21}{32}''/5/16''$), nickel finish, with Kaba-8-cylinder (length 25 mm [$0.984''$]) 1 press-fit sleeve, 2 keys, 2 half-round rods, 1500 mm ($4'11\frac{1}{16}''$), rod guides and strike plates (separate locking)	left 20873
		right 20874
	Concealed hinge, dull nickel finish, 110° (inset panels)	14528
	Concealed hinge, dull nickel finish, 120° (overlying panels)	15059
	Mortising template for cup recesses	14761

Order specifications

- Number and type of sets
- Number and type of profile sets
- Number of rollers and type of vertical seal profiles
- Number and type of accessories
- Whether with or without mortising template

Planning/installation

Please use the corresponding installation instructions: 15042 for folding panel pairs that are to be freely moved to and fro 14826 for folding panel pairs that are to be attached to the side. Each set of tracks contains installation instructions. (→ www.hawa.ch → Hawa Productfinder)