

KALABRONE

KALABRONE is the new shelf support for free-standing shelves created by Italiana Ferramenta Srl. Boasting a captivating design, it perfectly meets the actual market demands.

It is suitable for shelves from 8 to 30 mm thick. Its solid structure guarantees a capacity loading of 25 kg for each support with a shelf 320 mm deep.

KALABRONE comes with 2 adjustments:

- Vertical: through the oval hole positioned on the upper bracket
- Inclination: through an adjustable screw positioned on the main support

The soft element made of engineering plastic positioned on the upper bracket guarantees a perfect adhesion to the shelf, thus avoiding that the shelf is accidentally removed.

8-30 mm 

25 kg for each shelf support for shelf 320 mm deep 

REGISTERED DESIGN 

WOOD PANEL



Recommended fixing countersunk screw type - head Ø 5 mm max.

SOLID AND PLASTERBOARD WALLS

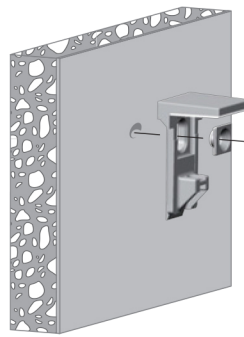

It is the responsibility of the customer:

- to ensure that the wall is of a suitable quality to hold the shelf fixing in place.
- to use the proper hardware fittings according to the construction of the wall.

For more specific information, please refer to the WARNINGS section at the end of the catalogue.

BRACKET ALIGNMENT

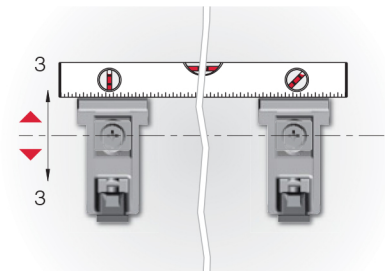

SHELF LOCKING AND INCLINATION ADJUSTMENT

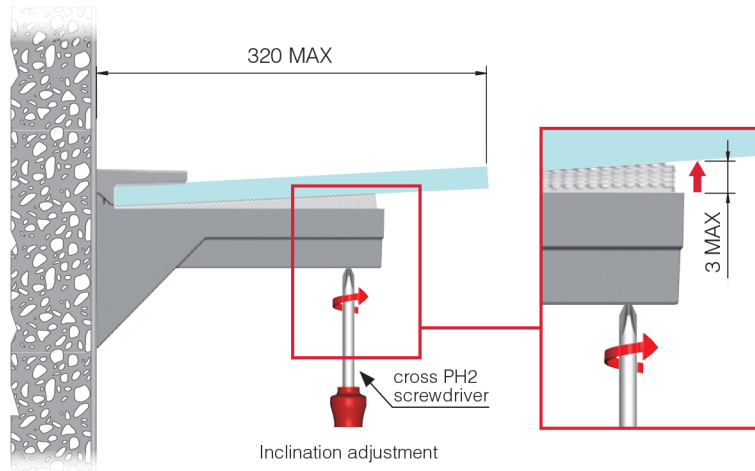
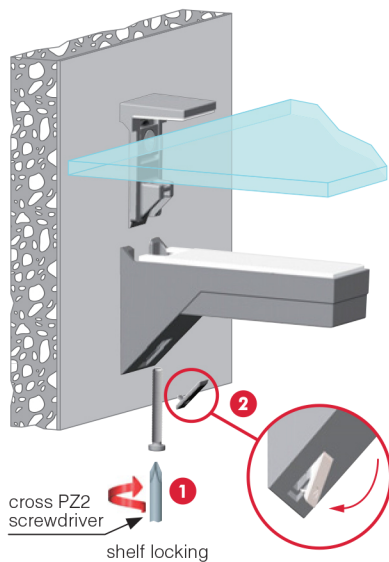

COMBINATION SHELF LOAD AND SHELF DEPTH

(The figures refer to 1 shelf support)

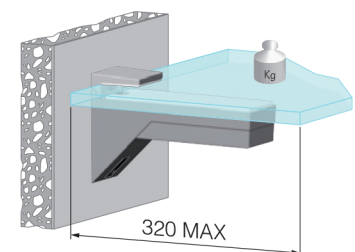
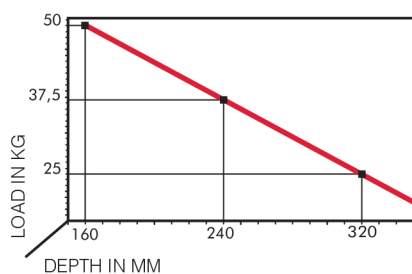

+ shelf weight = 25 kg MAX for each shelf support