







Fitting for top-running wooden doors up to 100 kg (220 lbs.), with surface mounted running track or running track flush with the ceiling. Optionally with soft and self closing mechanism. Ceiling mounting. Wall pocket solution.

Product highlights

-  **Comfort** Accessible opening and soft and self closing at both sides from door widths of 800 mm (2'7 1/2")
-  **Productivity** Easy height adjustment via both suspensions and convenient depth adjustment of the installed door
-  **Security** Performance guarantee: 15 years for private use and 7 years for commercial use on incomparably low opening forces of max. 22 N

Technical specifications

-  Max. 100 kg (220 lbs.)
-  Max. 4000 mm (13'1 15/32")
-  Max. 1500 mm (4'11 1/16")
-  35–80 mm (1 3/8" to 3 5/32")

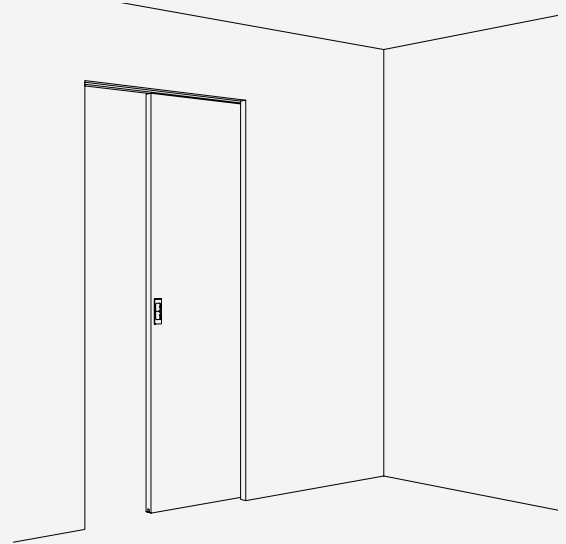

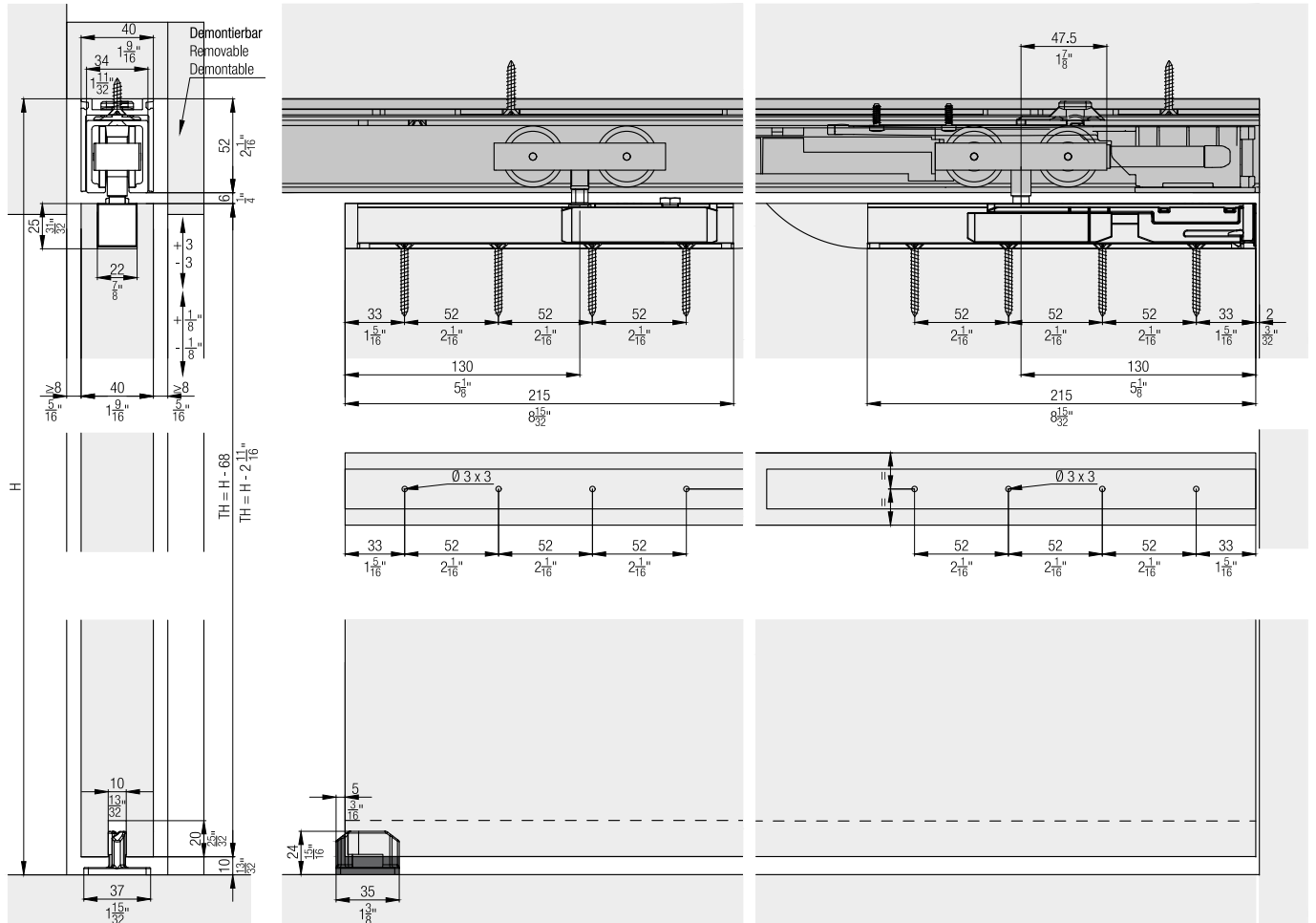

Installation examples



Set for 1 wooden door up to 100 kg (220 lbs.)

	No.
Hawa Junior 100 B Pocket, for 1 door	30154
Hawa Junior 100 B Pocket, +20 mm (+25/32"), for 1 door	30155

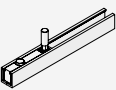
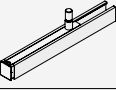
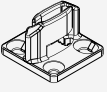

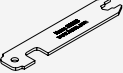
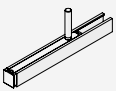
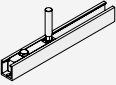
Set consisting of:

		30154	30155	No.
	Suspension profile, with plate, with suspension bolt M10, wall pocket installation	1		24323
	Suspension profile, plate with screw M10	1		24246
	Bottom guide, zero tolerance, groove width 10 mm, plastic, black	1	1	25369
	Screw-on rubber door stop	1	1	10629
	Locking wrench to suspension	1	1	10778
	Suspension profile, plate, with 20 mm longer screw M10, ceiling integration		1	24846
	Suspension profile, plate with 20 mm longer screw M10, for Pocket		1	26003

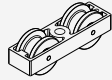

Set for 1 wooden door, with running gears and magnetic soft closing mechanism

	No.
Hawa Junior 100, 2 running gears, for 1 door	30064
Hawa Junior 100, 1 running gear, 1 SoftMove 100 with running gear and stopper, for 1 door	30149
Hawa Junior 100, 2 SoftMove 100 with running gear and stopper, for 1 door	30150

Set consisting of:

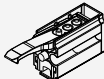
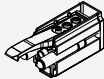

		30064	30149	30150	No.
	Running gear, 2-wheeled, M10, ball bearing	2	1		30137
	Soft close SoftMove 100, with running gear, stopper and cover, premounted		1	2	30509

Accessories for set

		No.
	Stopper Hawa Junior 80/100, with adjustable retention spring	30138
	SoftStop Hawa Junior 80/100, with adjustable retention spring	27771
	Spring loaded stopper Hawa Junior 80/100	25370

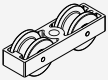
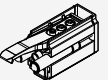
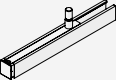
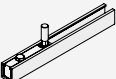
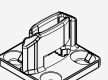

Complete set for 1 wooden door, with SoftStop and spring stop or SoftStop

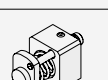
	No.
Hawa Junior 100 B Pocket, with 2 SoftStop, for 1 door	30248
Hawa Junior 100 B Pocket, with 1 SoftStop and 1 spring loaded stopper, for 1 door	30250

Set consisting of:			No.
	30248	30250	
 Running gear, 2-wheeled, M10, ball bearing	2	2	30137
 SoftStop Hawa Junior 80/100, with adjustable retention spring	2	1	27771
 Suspension profile, plate with screw M10	1	1	24246
 Suspension profile, with plate, with suspension bolt M10, wall pocket installation	1	1	24323
 Bottom guide, zero tolerance, groove width 10 mm, plastic, black	1	1	25369
 Locking wrench to suspension	1	1	10778
 Spring loaded stopper Hawa Junior 80/100		1	25370

Complete set for 1 wooden door, with SoftMove and/or SoftStop

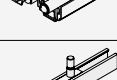
	No.
Hawa Junior 100 B Pocket, with 1 soft close SoftMove 100 and 1 SoftStop, for 1 door	30253
Hawa Junior 100 B Pocket, with 1 soft close SoftMove 100 and 1 spring loaded stopper, for 1 door	30254
Hawa Junior 100 B Pocket, with 2 soft close SoftMove 100, for 1 door	30255

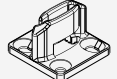
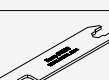
Set consisting of:				No.
	30253	30254	30255	
 Running gear, 2-wheeled, M10, ball bearing	1	1		30137
 Soft close SoftMove 100, with running gear, stopper and cover, premounted	1	1	2	30509
 SoftStop Hawa Junior 80/100, with adjustable retention spring		1		27771
 Suspension profile, plate with screw M10	1	1	1	24246
 Suspension profile, with plate, with suspension bolt M10, wall pocket installation	1	1	1	24323
 Bottom guide, zero tolerance, groove width 10 mm (13/32"), plastic, black	1	1	1	25369
 Locking wrench to suspension	1	1	1	10778
 Spring loaded stopper Hawa Junior 80/100		1		25370

Complete set for 1 wooden door, with 20 mm (25/32") longer suspension bolt and SoftStop

	No.
Hawa Junior 100 B Pocket, with 20 mm longer suspension bolt, 2 SoftStop, for 1 door	30259
Hawa Junior 100 B Pocket, with 20 mm longer suspension bolt, 1 SoftStop and 1 spring loaded stopper, for 1 door	30261

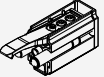
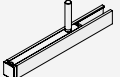
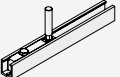
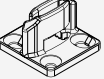
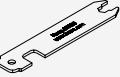
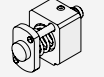

Set consisting of:

	30259	30261	No.
 Running gear, 2-wheeled, M10, ball bearing	2	2	30137
 SoftStop Hawa Junior 80/100, with adjustable retention spring	2	1	27771
 Suspension profile, plate, with 20 mm longer screw M10, ceiling integration	1	1	24846
 Suspension profile, plate with 20 mm longer screw M10, for Pocket	1	1	26003
 Bottom guide, zero tolerance, groove width 10 mm, plastic, black	1	1	25369
 Locking wrench to suspension	1	1	10778
 Spring loaded stopper Hawa Junior 80/100		1	25370

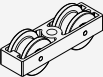

Complete set for 1 wooden door, with 20 mm (25/32") longer suspension bolt

	No.
Hawa Junior 100 B Pocket, with 20 mm longer suspension bolt, 1 soft close SoftMove 100 and 1 SoftStop, for 1 door	30264
Hawa Junior 100 B Pocket, with 20 mm longer suspension bolt, 1 soft close SoftMove 100 and 1 spring loaded stopper, for 1 door	30265
Hawa Junior 100 B Pocket, with 20 mm longer suspension bolt, 2 soft close SoftMove 100, for 1 door	30266

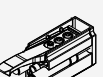
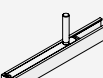
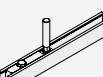
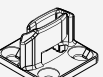
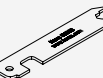
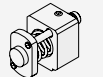
Set consisting of:

	30264	30265	30266	No.
 Running gear, 2-wheeled, M10, ball bearing	1	1		30137
 Soft close SoftMove 100, with running gear, stopper and cover, premounted	1	1	2	30509
 SoftStop Hawa Junior 80/100, with adjustable retention spring	1			27771
 Suspension profile, plate, with 20 mm (25/32") longer screw M10, ceiling integration	1	1	1	24846
 Suspension profile, plate with 20 mm (25/32") longer screw M10, for Pocket	1	1	1	26003
 Bottom guide, zero tolerance, groove width 10 mm (13/32"), plastic, black	1	1	1	25369
 Locking wrench to suspension	1	1	1	10778
 Spring loaded stopper Hawa Junior 80/100		1		25370

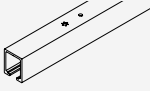
Running tracks

		mm (inch)	No.
	Running track, aluminum, anodized, pre-drilled	1,400 (4' 7 1/8 ")	10189
		1,600 (5' 3 ")	10190
		1,800 (5' 10 7/8 ")	10191
		2,000 (6' 6 3/4 ")	10192
		2,200 (7' 2 5/8 ")	10193
		2,500 (8' 2 7/16 ")	10194
		3,000 (9' 10 1/8 ")	18532
		cut to size	10188
	Running track, ceiling integration, aluminum, anodized, pre-drilled	2,500 (8' 2 7/16 ")	27664
		4,000 (13' 1 15/32 ")	27663
		6,000 (19' 8 7/32 ")	30325
		cut to size	27665



Guide tracks

		mm (inch)	No.
	Guide track, for groove mounting, plastic, 10-piece set	1,300 (4' 3 3/16 ")	14540

Assembly set, up to 2000 mm (6'6 3/4")

		No.
Set for mountable and demountable running track		25207

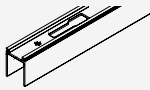

Set consisting of:

		mm (inch)	25207	No.
	Retainer profile with a bayonet lock, aluminum, anodized	2,035 (6' 8 1/8 ")	1	25212
	Small parts to retainer profile, 6-piece set		1	25520

Assembly set, up to 2500 mm (8'2 7/16")

		No.
Set for mountable and demountable running track		25371

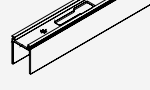

Set consisting of:

		mm (inch)	25371	No.
	Retainer profile with a bayonet lock, aluminum, anodized	2,535 (8' 3 13/16 ")	1	25443
	Small parts to retainer profile, 7-piece set		1	25521

Assembly set, up to 3000 mm (9'10 1/8")

		No.
Set for mountable and demountable running track		25441

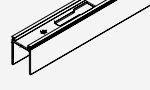
Set consisting of:

		mm (inch)	25441	No.
	Retainer profile with a bayonet lock, aluminum, anodized	3,035 (9' 11 1/2 ")	1	25444
	Small parts to retainer profile, 9-piece set		1	25522

Panels

		mm (inch)	No.
	Clip-on panel, for fascia mounting, aluminum, anodized	2,000 (6' 6 3/4 ")	25445
		cut to size	27693

Further installation examples

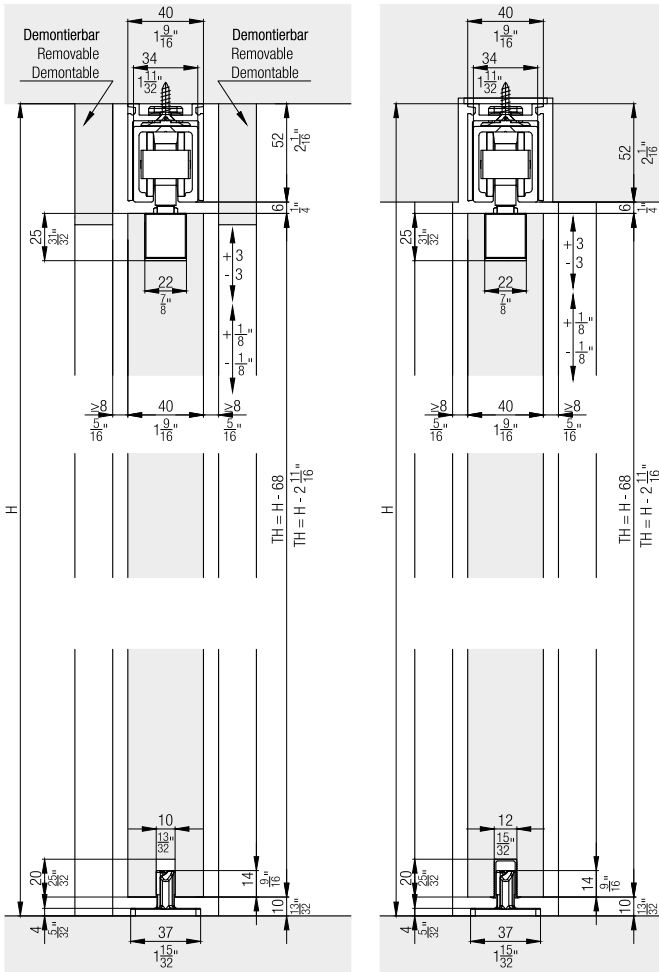

Calculations of running track length

The length of the running track must be shorter than the diagonal clearance (P2) by at least 80 mm (3 5/32").

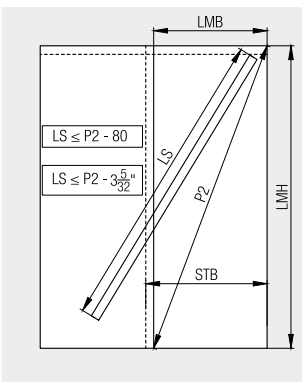

LMB = inside clearance
 LMH = inside height
 STB = sliding door width
 P2 = diagonal clearance
 LS = running track

Calculations of door width

The following factors affect the calculation of the width of the sliding door:

- Open or closed guide groove
- Construction with or without spring stop (25370)

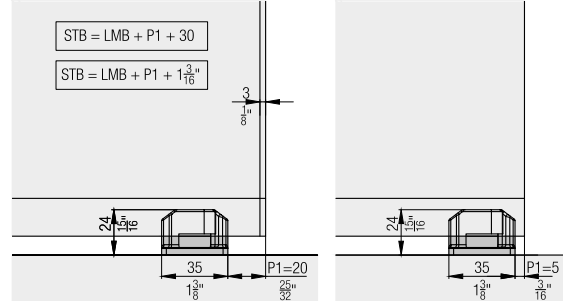

Facing for the retainer profile

The optional clip-on panel made of aluminum can be clipped onto the retainer profile without additional fixing components. For invisible fastening of the lintel panelling, there is the option of covering the clip panel on site, using panels up to 40 mm (1 9/16") thick.

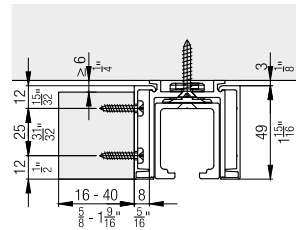

Spring stop

The specially developed spring stop for ejecting the door is integrated into the running track without visible fittings on the door edge.

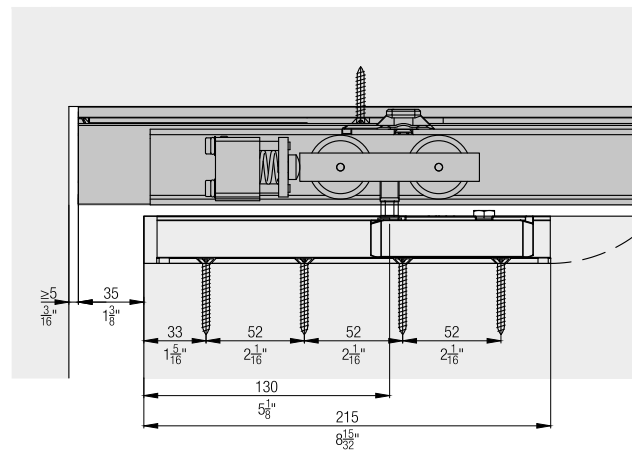

Version with 20 mm (25/32") longer hanger bolt

Thanks to the set with a longer hanger bolt, the running track can be covered from below, using removable ceiling elements.

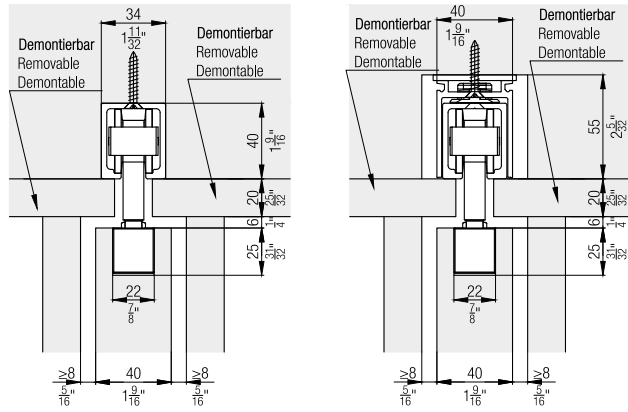

Ceiling integration

Recommendation: For systems integrated into the ceiling, provide assembly openings or front access to the system – front access of SoftMove is always mandatory.

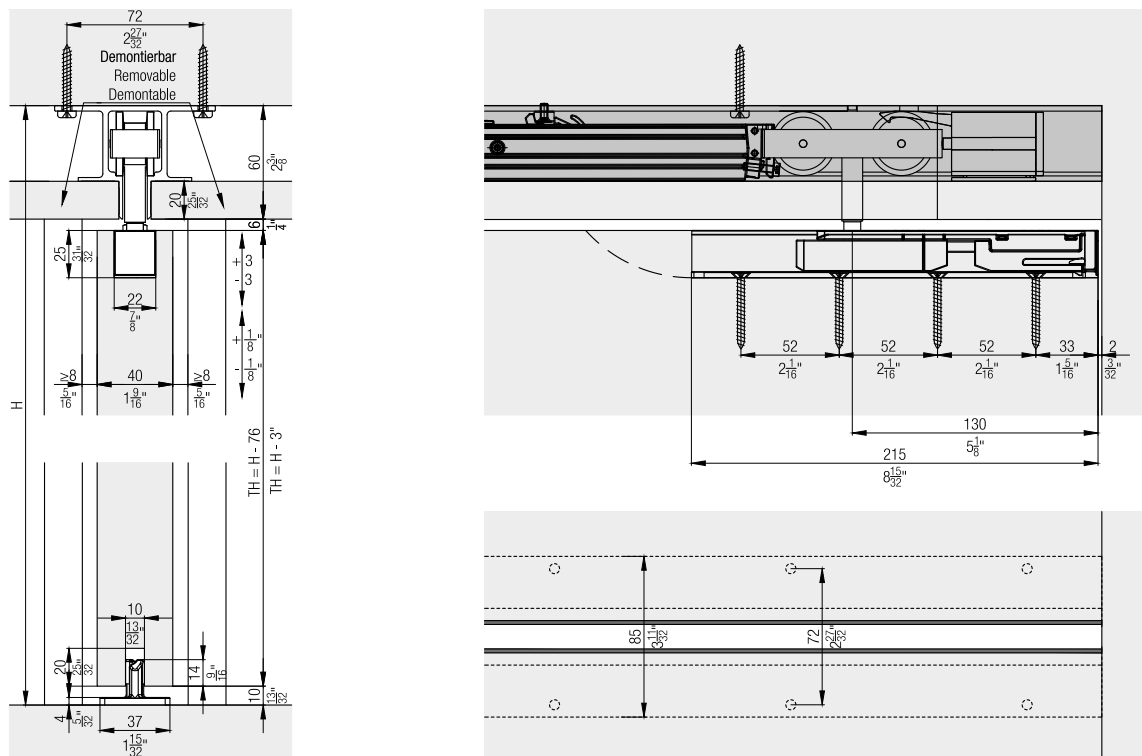

SoftMove 100 magnetic soft closing mechanism

Completely integrated into the running track, the SoftMove 100 decelerates sliding doors and draws them into their final position.

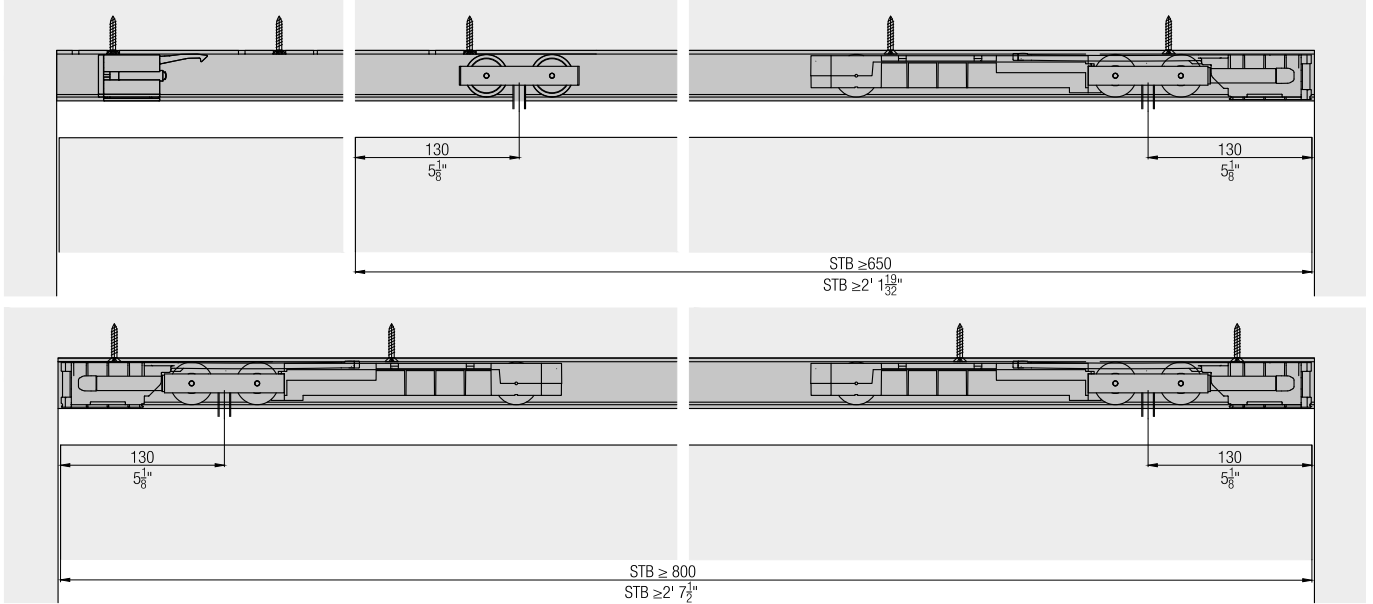

Accessories

- Hawa Junior bottom guides for wall mounting from page 508
- Lock solutions from page 511
- General accessories from page 518

Planning/execution

Further information about the product can be found on www.hawa.com.